



French developer and manufacturer since 1987



PRODUCT CATALOG
IMPLANTS DIFFUSION INTERNATIONAL



Since 1987, **IMPLANTS** DIFFUSION INTERNATIONAL, French company, manufactures dental implants. The company relies on a team of researchers, engineers and dental surgeons, in order to develop new products.

The **IMPLANTS** DIFFUSION INTERNATIONAL company invests a great deal in the research of new technologies such as the **TURBOdrill**[®], SMA +TiO₂ state of surface, Osteosinus...

« WE DESIGN AND MANUFACTURE IN FRANCE »

The **IDI** ranges are developed and manufactured in Ile-de-France region, near Paris city, by professionals who use all their know-how to satisfy practitioners. **IDI** applies a rigorous Quality policy, applied at all stages of manufacture.

The **IDI** Company is certified to the current standards.

The next decade will see the launching of various innovations emerging from our Research and Development Department.

Gérard **BOUKHRIS** - CEO



The French implant.

THE QUALITY COMMITMENT OF THE IDI COMPANY

THE LIFETIME WARRANTY

IDI - Implants Diffusion International- develops, manufactures and distributes the largest range of dental implants all over the world, as well as implantology and dental surgery equipment. IDI products are manufactured in France exclusively. They're resulting from the essential work of the Research and Development Department. For IDI, to be close with practitioners, hospitals and implantology training centres is a great deal, because they take part to the constant innovation.

The IDI teams, concerned with the trust relationship that they maintain with the practitioners, decided to offer **LIFETIME WARRANTIES TO ALL THE IMPLANT LINES** of the IDI brand.

Proud of our implant Quality, we supply an accurate customer service to assist you in your daily practice in order to meet your highest requirements. The "General Conditions" and the warranty protocol may be downloaded from the website, www.idi-dental.com, section: Documentations/Quality.

IDI puts the customer relationship at the heart of its concerns every day. The IDI team is regularly trained in the latest cutting-edge techniques and in all the products necessary to the implantologists.

Our Quality is a key asset to a stress-free practice.



Table of contents

IMPLANTS DIFFUSION INTERNATIONAL.....	2
The IDI Quality Commitment	3
IMPLANTS	7
Morse taper implants	7
The ID^{CAM} Range.....	8
The ID^{ALL} Range.....	22
Internal hexagonal implants	53
The ID^{BIO} Range	54
The ID^{MAX} Range	70
The narrow implants	87
The ID^{SLIM} Range.....	88
THE SURGICAL SETS AND DRILLS	91
The TURBOdrill[®] drill	92
The ID^{CAM} TURBOdrill[®] set	93
The ID^{ALL} TURBOdrill[®] set.....	94
The ID^{ALL} set	95
The Foret RBS C drill	96
The ID^{CAM/BIO} set	97
The RBS 3 set	98
The ID^{SLIM} set	99
OSTEOSINUS	100
ID'BOX	104
IDPARALLELISOR	104
IDSPASSOR	105
ACCESSORIES & INSTRUMENTS	106
BOX, IDPRO	106
Trepines, thread tap	106
Instruments, screwdriver	107
INFORMATIONS	108
Important considerations	108
Protocols	109
IDI scientific publications	111
Implants packaging	112
Warrantly IDI	113

THE SURFACE TREATMENT OF **THE IDI IMPLANTS**

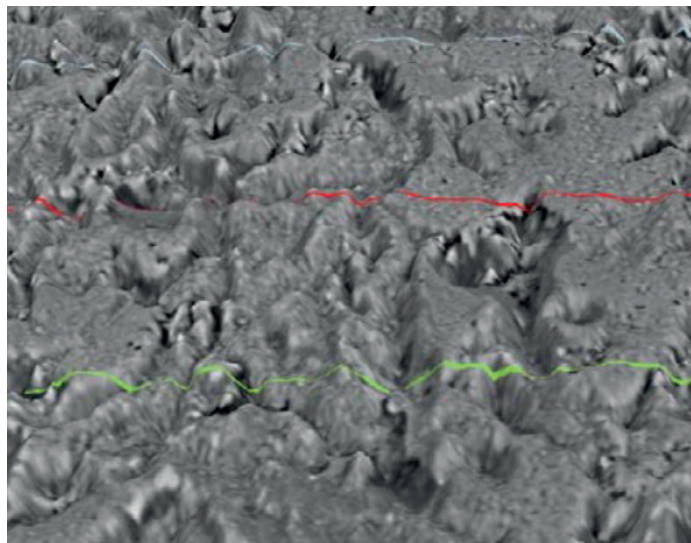

1987, IDI was the first company to produce an implant made of medical titanium alloy (Ti6Al4V) with a SMA TiO₂ surface treatment. This innovative surface treatment is still today **your best ally to succeed your implant surgery.**



Morse taper
IMPLANTS

IDCAM
&
IDALL
Ranges

ID^{CAM} M & ST IMPLANTS

Morse taper

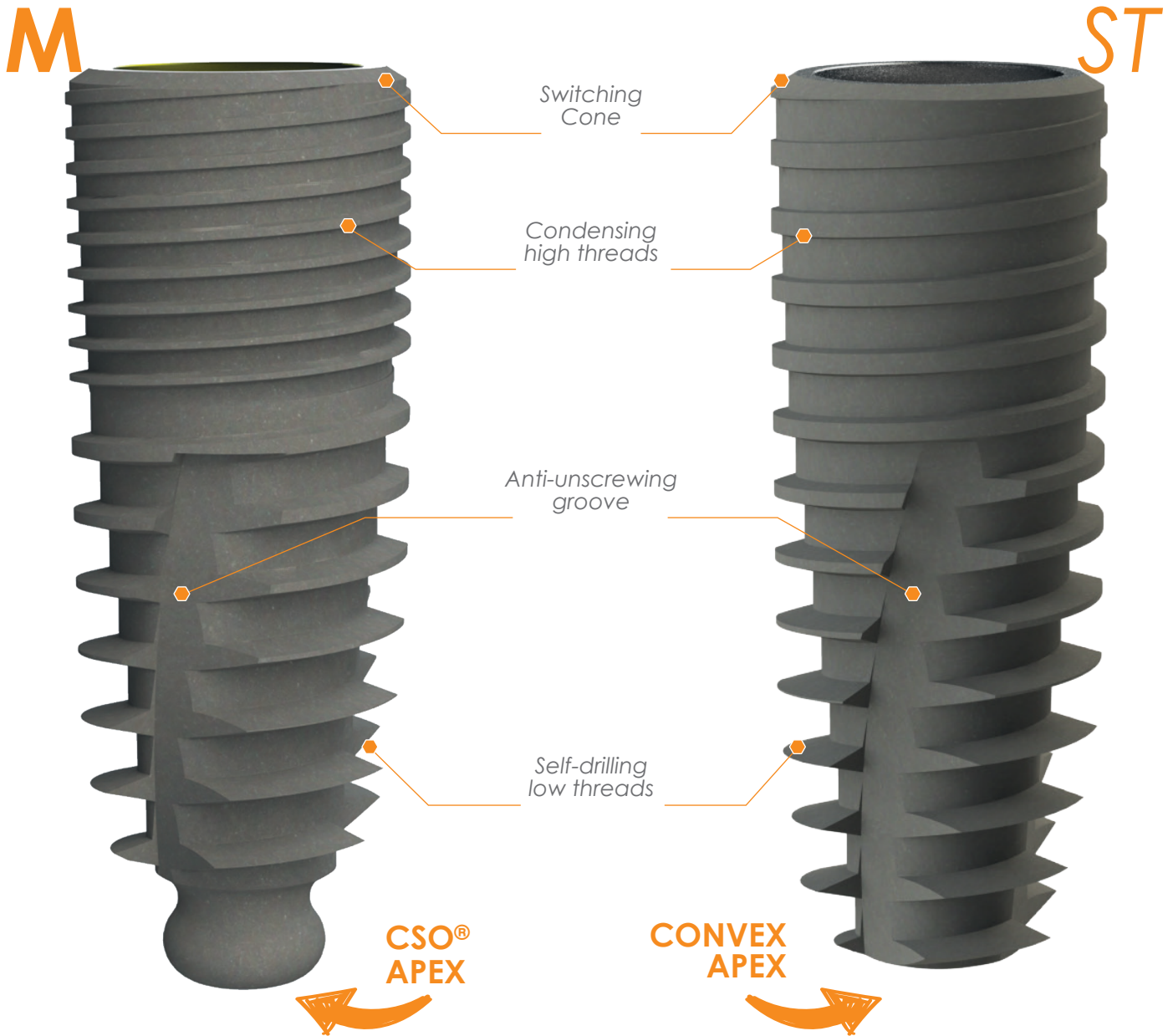

PRESENTATION

The ID^{CAM} range benefits from the SLA + TiO₂ state of surface initiated by IDI and used since 1987.

This self-condensing implant stands 75 N.cm screwing stress without being affected. The IDCAM implant draws special attention to itself due to its Switching Cone neck and to its cylindro-tapered body identical to a dental root.

The angulation, the state and the depth of the threads are specially studied to optimize the primary stabilization in any bone density and favor the immediate loading.

Refer to page 35

Implant ID^{CAM} features

- cylindro-tapered-shaped
- 2.5° morse taper
- Titan alloy TAL6VELI
- SLA + TiO₂ state of surface
- Cam retention
- Switching Cone
- Anti-unscrewing grooves
- Progressive and condensing threads
- Convex apex for ID^{CAM}ST
- CSO® apex for ID^{CAM}M

All the dimensions are in mm.

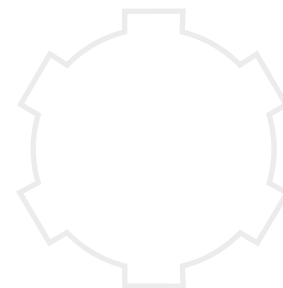

IMPLANTS RANGE



IDCAM M

IMPLANT TYPE	LENGTH Color code*	DIAMETER	PLATFORM	P/N
MULTI-THREADS	8 mm ●	4,2 mm	3,6 mm	IDCM0842
MULTI-THREADS	8 mm ●	5,2 mm	3,6 mm	IDCM0852
MULTI-THREADS & CSO APEX	10 mm ●	4,2 mm	3,6 mm	IDCM1042
MULTI-THREADS & CSO APEX	10 mm ●	5,2 mm	3,6 mm	IDCM1052
MULTI-THREADS & CSO APEX	12 mm ●	4,2 mm	3,6 mm	IDCM1242
MULTI-THREADS & CSO APEX	12 mm ●	5,2 mm	3,6 mm	IDCM1252
MULTI-THREADS & CSO APEX	15 mm ●	4,2 mm	3,6 mm	IDCM1542
MULTI-THREADS & CSO APEX	15 mm ●	5,2 mm	3,6 mm	IDCM1552



IDCAM ST

IMPLANT TYPE	LENGTH Color code*	DIAMETER	PLATFORM	P/N
STANDARD	8 mm ●	3,7 mm	3,6 mm	IDCS0835
STANDARD	8 mm ●	4,2 mm	3,6 mm	IDCS0842
STANDARD	8 mm ●	5,2 mm	3,6 mm	IDCS0852
STANDARD	10 mm ●	3,7 mm	3,6 mm	IDCST1035
STANDARD	10 mm ●	4,2 mm	3,6 mm	IDCST1042
STANDARD	10 mm ●	5,2 mm	3,6 mm	IDCST1052
STANDARD	12 mm ●	3,7 mm	3,6 mm	IDCST1235
STANDARD	12 mm ●	4,2 mm	3,6 mm	IDCST1242
STANDARD	12 mm ●	5,2 mm	3,6 mm	IDCST1252
STANDARD	15 mm ●	3,7 mm	3,6 mm	IDCST1535
STANDARD	15 mm ●	4,2 mm	3,6 mm	IDCST1542
STANDARD	15 mm ●	5,2 mm	3,6 mm	IDCST1552

*On each implant's packaging there is a small colored sticker to match with the implant height. The code for each color is related to the one found on the RBS conical and TURBOdrill® drills for the ID^{CAM} implants.

- Length: 8mm
- Length: 10mm
- Length: 12mm
- Length: 15mm

Morse taper

→ SURGICAL SCREWS

AESTHETIC HEALING CAP



DESCRIPTION	Ø LOW PART	Ø HIGH PART	HEIGHT	P/N
R SHAPE	3,6	4,2 mm	4 mm	R
S SHAPE	3,6	4,2 mm	6 mm	S
T SHAPE	3,6	5,4 mm	4 mm	T
U SHAPE	3,6	5,4 mm	6 mm	U
V SHAPE	3,6	5,4 mm	7 mm	V

CONICAL HEALING CAP

SCREW	Ø LOW PART	Ø HIGH PART	HEIGHT	P/N
	3,6 mm	4 mm	2 mm	021300
	3,6 mm	4 mm	4 mm	021301
	3,6 mm	6 mm	4 mm	021302
	3,6 mm	6 mm	6 mm	021303
	3,6 mm	4 mm	6 mm	021306
	3,6 mm	6 mm	8 mm	021308
	3,6 mm	4 mm	8 mm	021348
	3,6 mm	5 mm	2 mm	021350
	3,6 mm	5 mm	4 mm	021354
	3,6 mm	5 mm	6 mm	021356
	3,6 mm	5 mm	8 mm	021358

CLOSING CAP Ø3,6 MM



CYLINDRICAL HEALING CAP Ø3,2

SCREW	HEIGHT	P/N
	3,5 mm	021304
	5,5 mm	0213

Aesthetic prosthetic system

THE PROSTHETIC CURVED CONCEPT

The main advantages of this new abutment generation are :

- **The correspondence between the impression copyings / the healing cap / the abutment in order to MAXIMIZE THE AESTHETIC RESULT AND ELIMINATE THE GINGIVA COMPRESSION.**

Therefore, it is not necessary to anaesthetize the patient while abutment settlement.

- **THE FUNCTIONAL ASPECT IS PRESERVED thanks to the asymmetric shoulder shape**, including a lower vestibular zone than the proximal zone (papilla).

- **The golden colour of those elements plays a great role in the transgingival aesthetic aspect.**

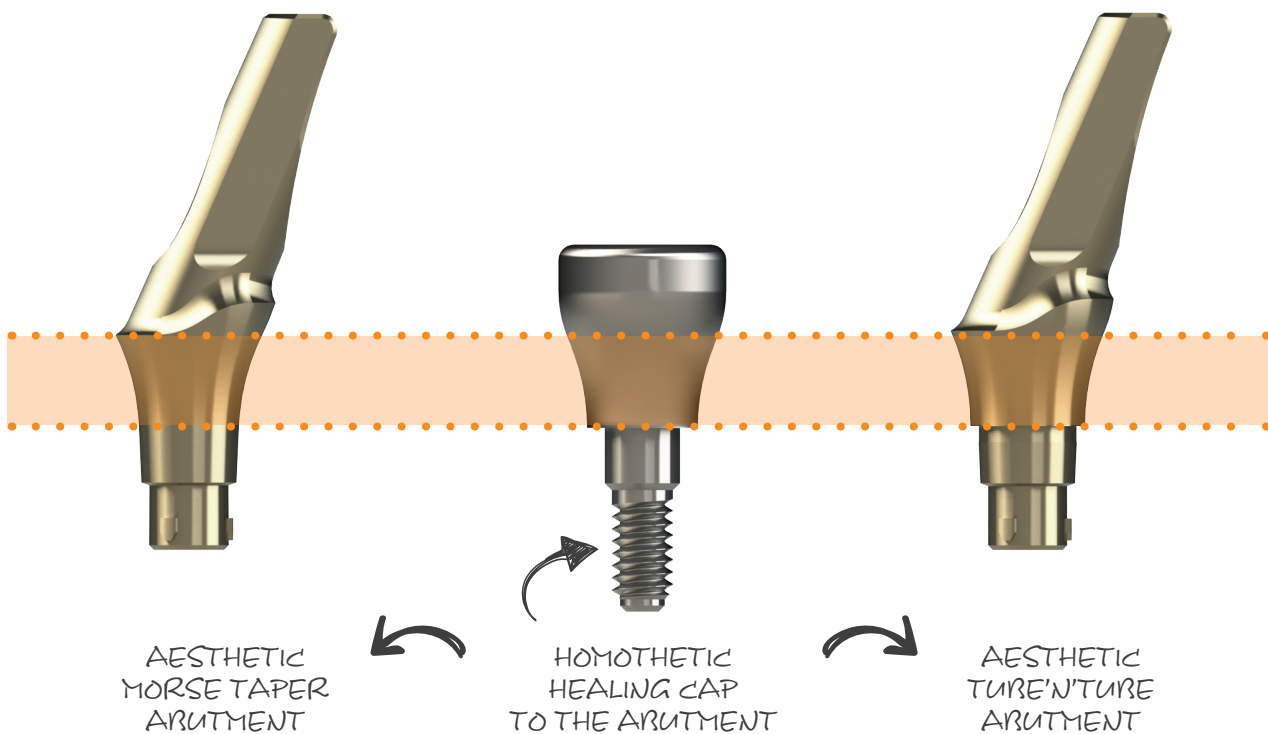

ID^{CAM} IMPLANTS

Prosthetic guide

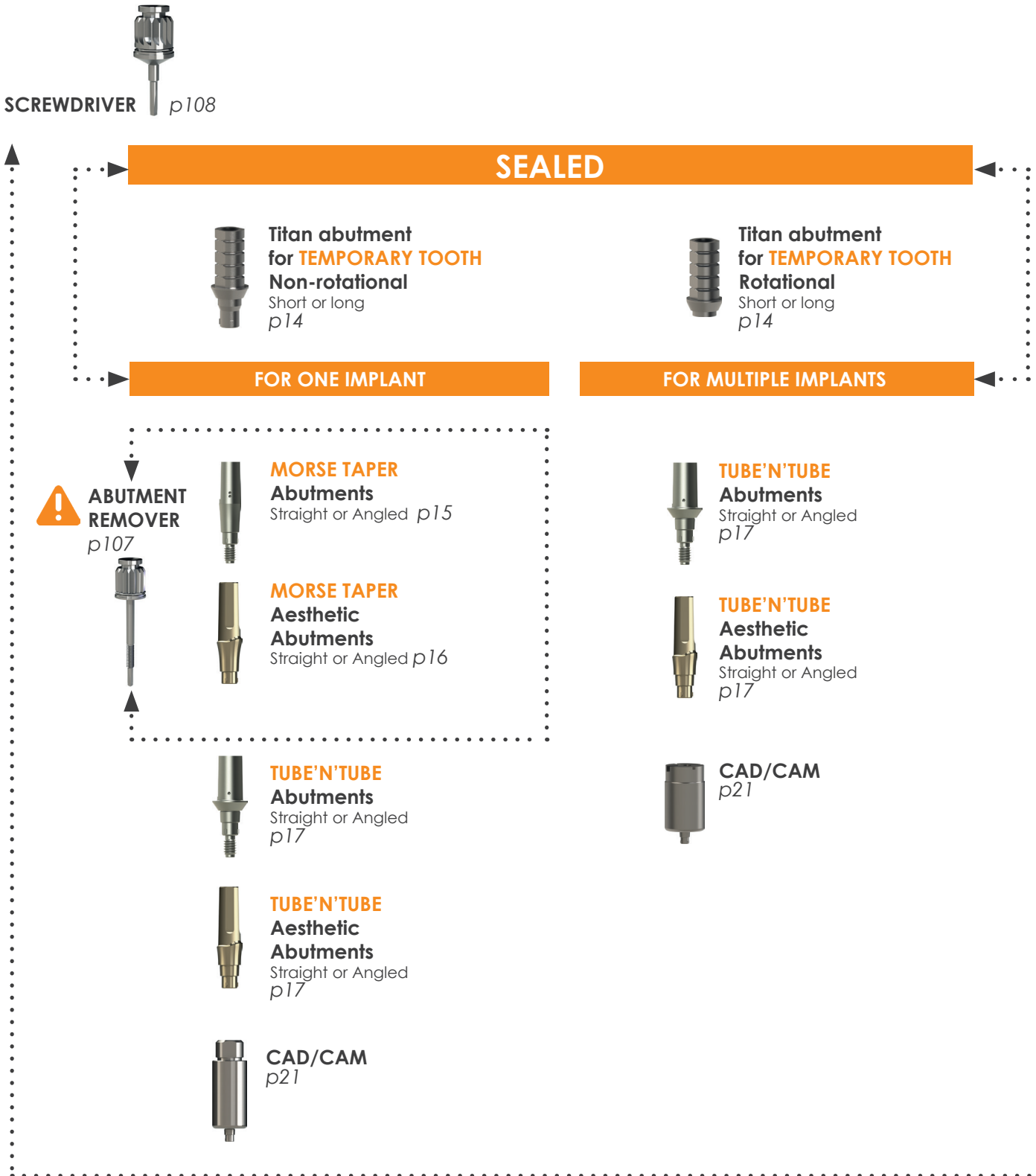

2 PROSTHETIC CONNEXION TYPE.
AN ANSWER TO EACH CASE.

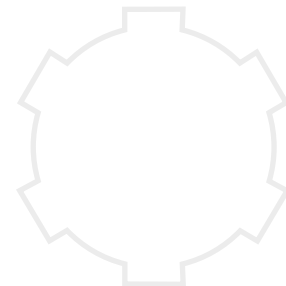

25
N.cm

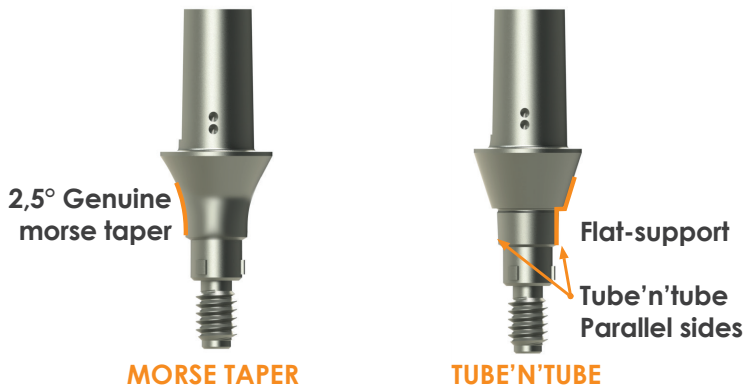

SCREWED



FOR ONE IMPLANT

FOR MULTIPLE IMPLANTS

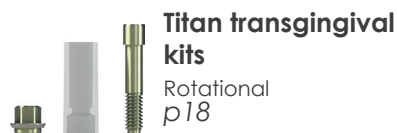
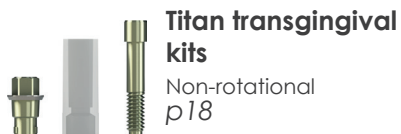



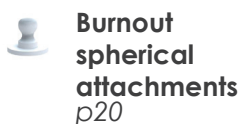



REMOVABLE









ID^{CAM} Prosthetic system





Morse Taper & Tube 'n' Tube

➔ PROSTHETIC COMPONENTS



IMPRESSION CYLINDER NON-ROTATIONAL		
	Pick-up technique	2004
	Closed tray technique	2004F
	Closed tray technique, long	2004FL
	Pick-up technique, narrow	2004N
	Closed tray technique, narrow long	2004NL
	Pick-up technique Plastic	2004P

IMPRESSION CYLINDER ROTATIONAL		
	Conical	0220C
	Rotational	0221
	Rotational long, special post-extractional	0221L

RETAINING SCREWS		
	Retaining screw for tapped screw-retained elements 25N.cm maximum	0211
	Retaining screw for ID ^{CAM} and ID ^{ALL} 25N.cm maximum	0214
	Long head screw for laboratory for all ranges, 25N.cm maximum	0217
	Short head, 25N.cm maximum	0219

SCANBODY		
	Scanbody CEREC® Bluecam S type (by 5)	6431295
	Scanbody CEREC® Bluecam L type (by 5)	6431303
	Scanbody CEREC® Omnicam S type (by 5)	6431311
	Scanbody CEREC® Omnicam L type (by 5)	6431329

IMPLANT ANALOG		
	Implant analog Ø3,6 mm	0223

CEREC TIBASE		
	Titan base for CEREC Ø3,6mm	7336
	Titan base for CEREC Ø3,1mm	7436

➔ THE TEMPORARY PROSTHESIS

TITAN ABUTMENTS FOR A TEMPORARY TOOTH FOR ONE IMPLANT RESTORATION		
	Non-rotational - Ø3,6 mm	0206
	Temporary titan abutment, long (post-extractional for switching platform)	0206L

TITAN ABUTMENTS FOR A TEMPORARY TOOTH FOR MULTIPLE IMPLANTS RESTORATION		
	Rotational - Ø3,6 mm	0208
	Temporary titan abutment, long (post-extractional for switching platform)	0208L

All the dimensions are in mm.

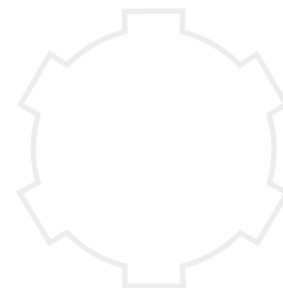

THE SEALED PROSTHESIS



MORSE TAPER ABUTMENTS			
WITH SHOULDER OF Ø5,4 MM		H.T.*	
	Straight	1,5 mm	420001
	Straight	2,5 mm	420002
	Straight	3,5 mm	420003
	Straight	5 mm	420005
	Angled 7°	1,5 mm	420701
	Angled 7°	3,5 mm	420703
	Angled 7°	5 mm	420705
	Angled 15°	1,5 mm	421501
	Angled 15°	2,5 mm	421502
	Angled 15°	3,5 mm	421503
	Angled 15°	5 mm	421505
	Angled 23°	1,5 mm	422301
	Angled 23°	2,5 mm	422302
	Angled 23°	3,5 mm	422303
	Angled 23°	5 mm	422305

MORSE TAPER ABUTMENTS				
WITHOUT SHOULDER		H.T.*	Ø3,6	Ø4,2
	Straight	1,5 mm	3500	4200
	Straight	3,5 mm	35003	42003
	Straight	5 mm	35005	42005
	Angled 7°	1,5 mm	35071	42071
	Angled 7°	3,5 mm	35073	42073
	Angled 7°	5 mm	35075	42075
	Angled 15°	1,5 mm	3515	4215
	Angled 15°	3,5 mm	35153	42153
	Angled 15°	5 mm	35155	42155
	Angled 23°	1,5 mm	3523	4223
	Angled 23°	3,5 mm	35233	42233
	Angled 23°	5 mm	35235	42235

*H.T. : Transgingival height



USE THE MORSE TAPER ABUTMENT REMOVER, if needed.
p107



IDCAM Prosthetic system

Morse Taper & Tube 'n' Tube

MORSE TAPER ABUTMENTS KIT

Kit part number P/N : 0242 + 0142 + 4212 + 4213 Ø4,2 - L.3,5 - Transgingival Height 0,5	KITB	Kit 4200 + 0211 + 0223	KITC400
Kit P/N : 3500 + 0211 + 0223	KITC300	Kit 420001 + 0211 + 0223	KITC400H1
Kit P/N : 3515 + 0211 + 0223	KITC315	Kit 4215 + 0211 + 0223	KITC415
Kit P/N : 3523 + 0211 + 0223	KITC323	Kit 4223 + 0211 + 0223	KITC423



USE THE MORSE TAPER ABUTMENT REMOVER, if needed.
p107



MORSE TAPER AESTHETIC ABUTMENTS

ANGULATION	TRANSGINGIVAL HEIGHT	Ø4	HEALING CAP	Ø5	HEALING CAP
Straight	1,5 mm	C34001R	R	C35001T	T
Straight	3,5 mm	C34003S	S	C35003U	U
Straight	5 mm	C34005S	S	C35005V	V
Angled 15°	1,5 mm	C34151R	R	C35151T	T
Angled 15°	3,5 mm	C34153S	S	C35153U	U
Angled 15°	5 mm	C34155S	S	C35155V	V
Angled 23°	1,5 mm	C34231R	R	C35231T	T
Angled 23°	3,5 mm	C34233S	S	C35233U	U
Angled 23°	5 mm	C34235S	S	C35235V	V



HOMOTHETIC HEALING CAP

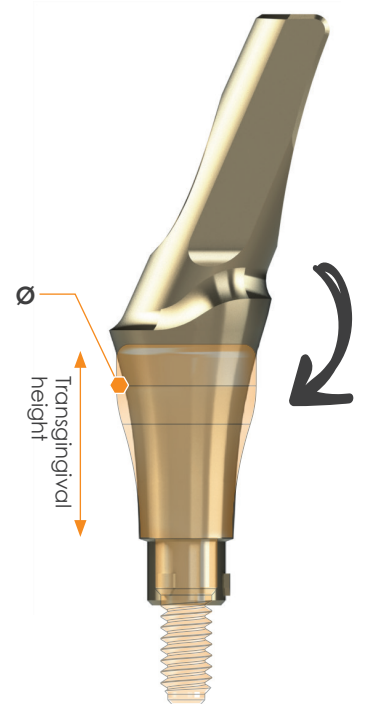

All the dimensions are in mm.

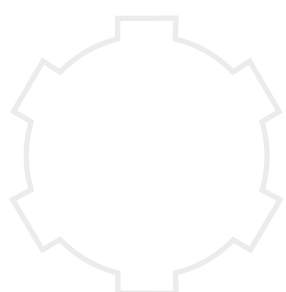

THE SEALED PROSTHESIS

FOR ONE IMPLANT & FOR MULTIPLE IMPLANTS

TUBE'N'TUBE ABUTMENTS			
WITH SHOULDER OF Ø5,4 MM		TRANSGINGIVAL HEIGHT	
	Straight	1,5 mm	420011
	Straight	3 mm	420012
	Angled 15°	1,5 mm	421511
	Angled 15°	3 mm	421512
	Angled 23°	1,5 mm	422311
	Angled 23°	3 mm	422312

TUBE'N'TUBE ABUTMENTS KIT	
Kit Réf. : 420011 + 0211 + 0223	KITD400

TUBE'N'TUBE AESTHETIC ABUTMENTS						
ANGULATION		TRANSGINGIVAL HEIGHT	Ø4	HEALING CAP	Ø5	HEALING CAP
	Straight	1,5 mm	T34001R	R	T35001T	T
	Straight	3 mm	T34003S	S	T35003U	U
	Angled 15°	1,5 mm	T34151R	R	T35151T	T
	Angled 15°	3 mm	T34153S	S	T35153U	U
	Angled 23°	1,5 mm	T34231R	R	T35231T	T
	Angled 23°	3 mm	T34233S	S	T35233U	U

HOMOTHETIC HEALING CAP



ID^{CAM} Prosthetic system

Morse Taper & Tube 'n' Tube



THE SCREWED PROSTHESIS

FOR ONE IMPLANT

BURNOUT CYLINDER		
	Non-rotational with shoulder in nylon Ø4,8 mm, for temporary tooth	022602

TRANSGINGIVAL KIT NON-ROTATIONAL		
Ø3,6 MM	TRANSGINGIVAL HEIGHT	
	0,4 mm	6360H
	1,4 mm	6361H
	2,4 mm	6362H





CEREC TIBASE		
	Titan base for CEREC Ø3,6 mm	7336
	Titan base for CEREC Ø3,1 mm	7436

FOR MULTIPLE IMPLANTS

BURNOUT CYLINDER		
	Rotational with shoulder Ø4,8 mm	021801

KIT BURNOUT CYLINDER		
The screw-on burnout elements for any type of prosthetic reconstructions Kit P/N : 0223 + 0214 + 021801 + 0931 + 0025		KITA

TRANSGINGIVAL KIT ROTATIONAL		
Ø3,6 MM	TRANSGINGIVAL HEIGHT	
	0,4 mm	6360R
	1,4 mm	6361R
	2,4 mm	6362R



All the dimensions are in mm.

THE SCREWED PROSTHESIS

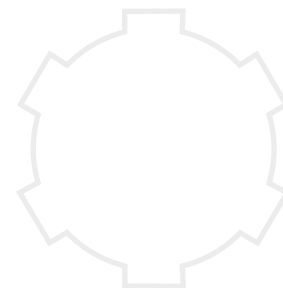



FOR MULTIPLE IMPLANTS

IDUNIT SYSTEM

IDUNIT IMPLANT ANALOG

	Implant analog	333
---	----------------	-----

IDUNIT IMPRESSION COPYING

	Closed tray technique	321
	Pick-up technique	322
	Pick-up technique, long	322L

IDUNIT RETAINING SCREW

	For prosthetic elements : 334 and 336. Maximum 15 N.cm	0216
---	---	------

IDUNIT BURNOUT CYLINDER

	Burnout element + screw. P/N : 0216	336S
---	-------------------------------------	------

IDUNIT TEMPORARY CYLINDER

	for IDUNIT + Screw P/N : 0216	334
---	-------------------------------	-----

IDUNIT HEALING CAP

	for IDUNIT	330
---	------------	-----

IDUNIT ABUTMENTS

	ANGULATION	TRANSGINGIVAL HEIGHT	
	Straight	1 mm	U3601
	Straight	2,5 mm	U3602
	Straight	4 mm	U3604
	Straight	6 mm	U3606
	Angled 17°	1 mm	U3621
	Angled 17°	3 mm	U3623
	Angled 17°	5 mm	U3625
	Angled 30°	1 mm	U3631
	Angled 30°	3 mm	U3633
	Angled 30°	5 mm	U3635



IDCAM Prosthetic system





Morse Taper & Tube 'n' Tube

THE REMOVABLE PROSTHESIS





SPHERICAL ATTACHMENTS

	Transgingival height 1 mm	222361
	Transgingival height 2,5 mm	222362
	Transgingival height 4 mm	222364
	Transgingival height 6 mm	222366

BOXES FOR SPHERICAL ATTACHMENTS

	O'ring height:3,5mm Ø external 5mm	0122
	Nitrile retaining ring <i>soft</i> (white)	0120NB
	O'ring retaining ring for O'ring attachment <i>medium</i> (red)	0120SR
	O'ring retaining ring for O'ring attachment <i>strong</i> (black)	0120NN

THE BURNOUT ELEMENTS

	Spherical attachments	9222
	Paralleling guide for burnout spherical attachments	9223
	Burnout connector bar by 3	0931
	Nylon cap	0025

IDLOC SYSTEM

IDLOC IMPLANT ANALOG

	Implant analog	433
--	----------------	-----

IDLOC IMPRESSION COPYING

	Plastic	432
--	---------	-----

IDLOC ATTACHMENT BOX

	Female part (Locator) Thickness 2,5mm	LOCFEM
--	---	--------

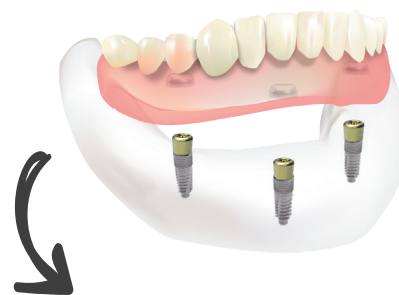

IDLOC ATTACHMENTS

	Transgingival height 1 mm	L3601
	Transgingival height 2,5 mm	L3602
	Transgingival height 4 mm	L3604
	Transgingival height 6 mm	L3606



All the dimensions are in mm.

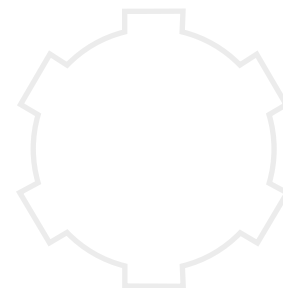

The CAD/CAM for ID^{CAM} implants





IMPLANT ANALOG		
	Digital repositionable cams Ø3,6 mm	0223N

TITANIUM SCANBODY		
	CAD/CAM impression copying Cam connection	SBCT

PREMILLED ABUTMENT Ø12		
	Conical	PMC12
	Tube'n'Tube	PMP12

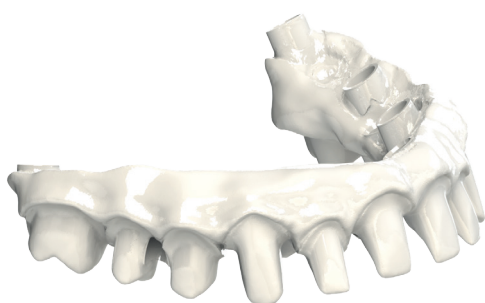

PREMILLED ABUTMENT <i>Medentika Type</i> Ø12		
	Conical	PMC12M
	Tube'n'Tube	PMP12M







IDUNIT		
	IDUnit Tibase + screw P/N 0216	TU
	IDUnit CAD/CAM impression copying	321P



TIBASES

TUBE'N'TUBE ROTATIONAL CONNECTION Ø 3.6MM		
	Height 0,5 mm With screw P/N 0211	TR360
	Height 2 mm With screw P/N 0211	TR362
	Height 4 mm With screw P/N 0211	TR364

CONICAL CONNECTION Ø 3.6MM		
	Height 0,5 mm With screw P/N 0211	TC320
	Height 2 mm With screw P/N 0211	TC322
	Height 4 mm With screw P/N 0211	TC324

TUBE'N'TUBE CAM CONNECTION Ø 3.6MM		
	Height 0,5 mm With screw P/N 0211	TP360
	Height 2 mm With screw P/N 0211	TP362
	Height 4 mm With screw P/N 0211	TP364

Morse Taper

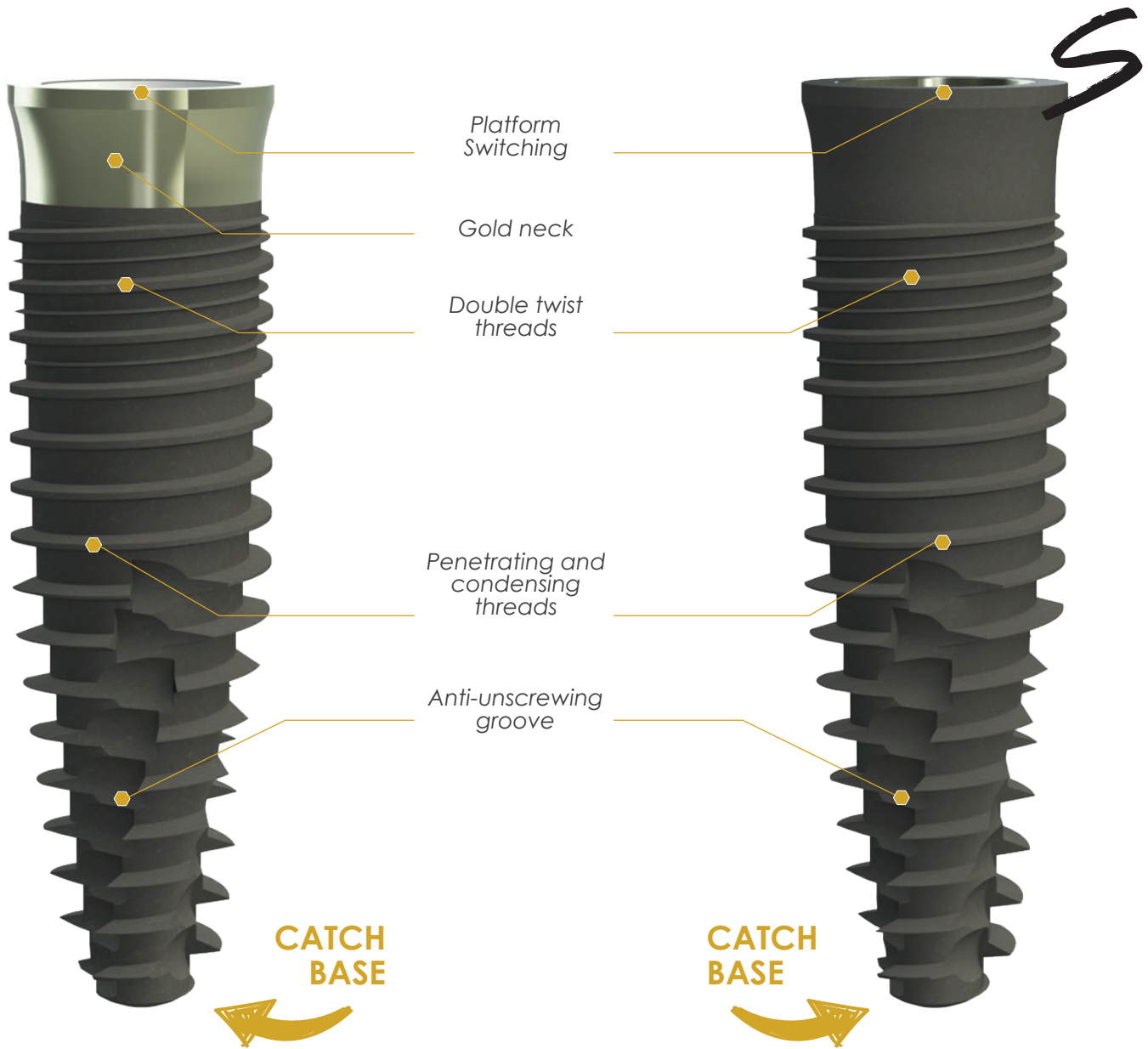

PRESENTATION

The ID^{ALL} range benefits from the latest technological advance, to be associated with the IDI fundamentals such as the S.M.A. and TiO₂ state of surface common to all the implant ranges.

This self-drilling implant stands 75N.cm screwing stress without being affected.

The ID^{ALL} implants draws special attention to itself thanks to its aesthetic gold polished neck, and thanks to its platform switch that minimizes the bone loss and makes the crest extension being possible.

Its design is specially studied to optimize the primary stabilization in any bone density and favor the immediate loading.

Refer to page 35

Features of the ID^{ALL} implant

- Cylindro-tapered shape
- Platform Switching
- Gold neck
- Ti6Al4V ELI titanium alloy
- S.M.A. and TiO₂ coated
- Morse taper
- Cam connection
- Anti-unscrewing groove
- Penetrating and condensing threads
- Double twist threads
- Catch base

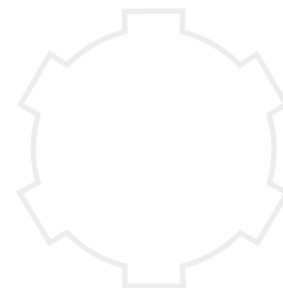

IMPLANT RANGES



DESCRIPTION	LENGTH Color code*	DIAMETER	P/N
AESTHETIC NECK	8 mm ●	3,8 mm	IDA0838
AESTHETIC NECK	8 mm ●	4,2 mm	IDA0842
AESTHETIC NECK	8 mm ●	5,2 mm	IDA0852
AESTHETIC NECK	10 mm ●	3,8 mm	IDA1038
AESTHETIC NECK	10 mm ●	4,2 mm	IDA1042
AESTHETIC NECK	10 mm ●	5,2 mm	IDA1052
AESTHETIC NECK	12 mm ●	3,8 mm	IDA1238
AESTHETIC NECK	12 mm ●	4,2 mm	IDA1242
AESTHETIC NECK	12 mm ●	5,2 mm	IDA1252
AESTHETIC NECK	15 mm ●	3,8 mm	IDA1538
AESTHETIC NECK	15 mm ●	4,2 mm	IDA1542
AESTHETIC NECK	15 mm ●	5,2 mm	IDA1552
AESTHETIC NECK	18 mm ●	3,8 mm	IDA1838
AESTHETIC NECK	18 mm ●	4,2 mm	IDA1842
AESTHETIC NECK	18 mm ●	5,2 mm	IDA1852

*On each implant packaging there is a small colored sticker to match with the implant length. The colored sticker is related to the ID^{ALL} drills and the ID^{ALL}TURBOdrill® color codes :

- 8 mm length
- 10 mm length
- 12 mm length
- 15 mm length
- 18 mm length



DESCRIPTION	LENGTH Color code*	DIAMETER	P/N
SANDBLASTED NECK	10 mm ●	4,2 mm	IDAS1042
SANDBLASTED NECK	10 mm ●	5,2 mm	IDAS1052
SANDBLASTED NECK	12 mm ●	4,2 mm	IDAS1242
SANDBLASTED NECK	12 mm ●	5,2 mm	IDAS1252
SANDBLASTED NECK	15 mm ●	4,2 mm	IDAS1542
SANDBLASTED NECK	15 mm ●	5,2 mm	IDAS1552
SANDBLASTED NECK	18 mm ●	4,2 mm	IDAS1842
SANDBLASTED NECK	18 mm ●	5,2 mm	IDAS1852

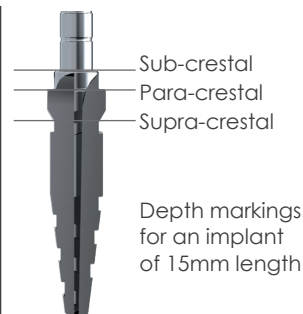

There is one drill for each implant length.

Morse Taper

→ SURGICAL SCREWS

AESTHETIC HEALING CAP



DESCRIPTION	Ø LOW PART	Ø HIGH PART	HEIGHT	P/N
R SHAPE	3,6	4,2 mm	4 mm	R
S SHAPE	3,6	4,2 mm	6 mm	S
T SHAPE	3,6	5,4 mm	4 mm	T
U SHAPE	3,6	5,4 mm	6 mm	U
V SHAPE	3,6	5,4 mm	7 mm	V
W SHAPE	4,2	5,4 mm	4 mm	W
X SHAPE	4,2	5,4 mm	6 mm	X
Y SHAPE	4,2	6 mm	4 mm	Y
Z SHAPE	4,2	6 mm	6 mm	Z

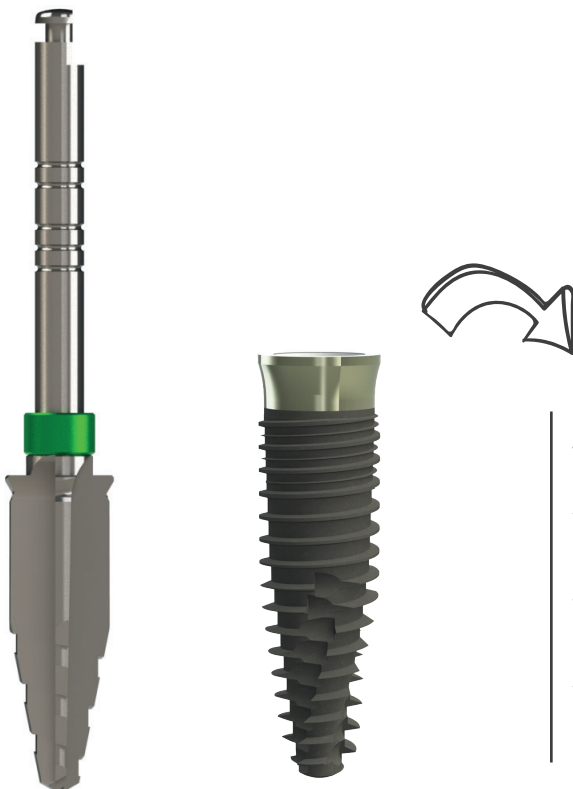

THE CONCEPT 1 DRILL / 1 IMPLANT







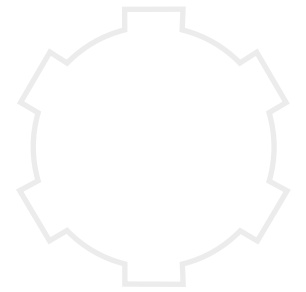



Thanks to ID^{ALL} concept: 1 drill / 1 implant, in most of the cases it is possible to use only 1 drill to insert an implant. This procedure allows to obtain a more precise drilling implant.

This precision include an optimal primary stabilisation which allows an excellent implant bone integration.

This concept was approved by several international scientific published studies.





CONICAL HEALING CAP

SCREW	Ø LOW PART	Ø HIGH PART	HEIGHT	P/N
	3,6 mm	4 mm	2 mm	021300
	3,6 mm	4 mm	4 mm	021301
	3,6 mm	6 mm	4 mm	021302
	3,6 mm	6 mm	6 mm	021303
	3,6 mm	4 mm	6 mm	021306
	3,6 mm	6 mm	8 mm	021308
	3,6 mm	4 mm	8 mm	021348
	3,6 mm	5 mm	2 mm	021350
	3,6 mm	5 mm	4 mm	021354
	3,6 mm	5 mm	6 mm	021356
	3,6 mm	5 mm	8 mm	021358

CYLINDRICAL HEALING CAP Ø3,2

SCREW	HEIGHT	P/N
	3,5 mm	021304
	5,5 mm	0213

CLOSING CAP

SCREW	DIAMETER	P/N
	3,6 mm	0212
	4,2 mm	021201
	5,2 mm	021202

ID^{ALL} IMPLANTS

Prosthetic guide

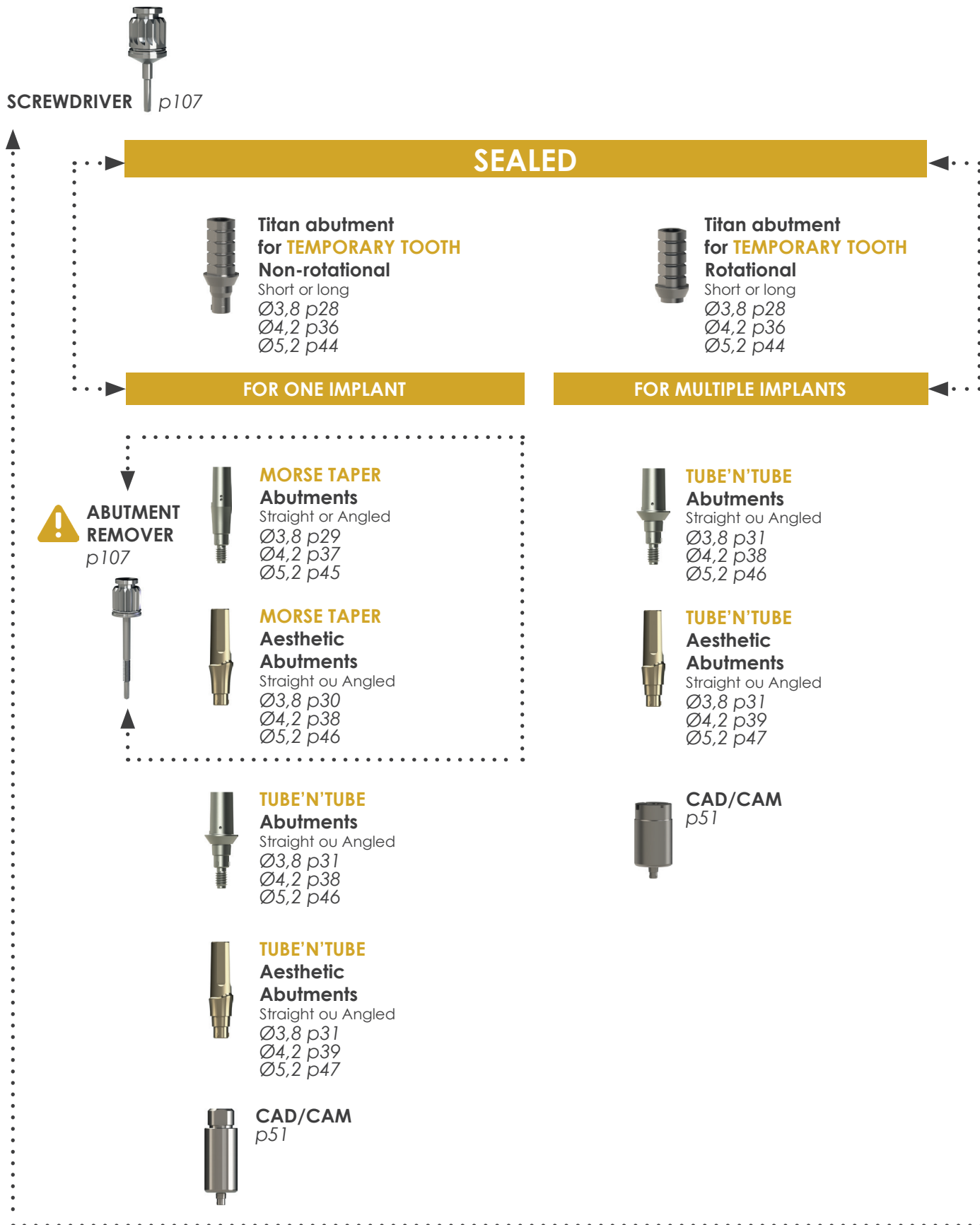

All the dimensions are in mm.

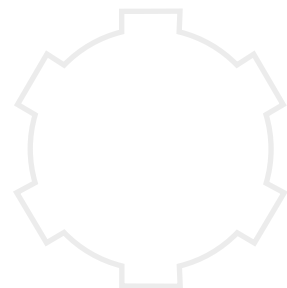
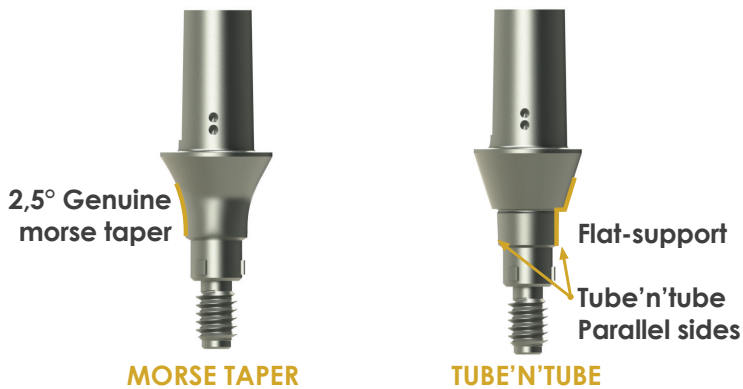

SCREWED

Titan abutment for TEMPORARY TOOTH IDUnit
 Ø3,8 p33
 Ø4,2 p41
 Ø5,2 p49

FOR ONE IMPLANT

FOR MULTIPLE IMPLANTS

Titan transgingival kits
 Non-rotational
 Ø3,8 p32
 Ø4,2 p40
 Ø5,2 p48

IDUnit Attachments
 Straight ou Angled
 Ø3,8 p33
 Ø4,2 p41
 Ø5,2 p49

CEREC Tibase
 Ø3,8 p32
 Ø4,2 p40
 Ø5,2 p48

Titan transgingival kits
 Rotational
 Ø3,8 p32
 Ø4,2 p40
 Ø5,2 p48

CAD/CAM
 p51

CAD/CAM
 p51

REMOVABLE

Spherical attachments
 Ø3,8 p34
 Ø4,2 p42
 Ø5,2 p50







Burnout spherical attachments
 Ø3,8 p34
 Ø4,2 p42
 Ø5,2 p50



IDLoc Attachments
 Ø3,8 p34
 Ø4,2 p42
 Ø5,2 p50

ID^{ALL} Ø3,8 Prosthetic system





Morse Taper & Tube'n'Tube

→ PROSTHETIC COMPONENTS

IMPRESSION CYLINDER NON-ROTATIONAL		
	Pick-up technique	2004
	Closed tray technique	2004F
	Closed tray technique, long	2004FL
	Pick-up technique, narrow	2004N
	Closed tray technique, narrow long	2004NL
	Pick-up technique Plastic	2004P



IMPRESSION CYLINDER ROTATIONAL		
	Conical	0220C
	Rotational	0221
	Rotational long, special post-extractional	0221L

IMPLANT ANALOG		
	Implant analog Ø3,6 mm	0223

RETAINING SCREWS		
	Retaining screw for tapped screw-retained elements 25N.cm maximum	0211
	Retaining screw for ID ^{CAM} and ID ^{ALL} 25N.cm maximum	0214
	Long head screw for laboratory for all ranges, 25N.cm maximum	0217
	Short head, 25N.cm maximum	0219

→ THE TEMPORARY PROSTHESIS

TITAN ABUTMENTS FOR A TEMPORARY TOOTH FOR ONE IMPLANT RESTORATION		
	Non-rotational - Ø3,6 mm	0206
	Temporary titan abutment, long (post-extractional for switching platform)	0206L

TITAN ABUTMENTS FOR A TEMPORARY TOOTH FOR MULTIPLE IMPLANTS RESTORATION		
	Rotational - Ø3,6 mm	0208
	Temporary titan abutment, long (post-extractional for switching platform)	0208L

All the dimensions are in mm.



THE SEALED PROSTHESIS

↪ FOR ONE IMPLANT

MORSE TAPER ABUTMENTS			
	WITH SHOULDER OF Ø5,4 MM	TRANSGINGIVAL HEIGHT	
	Straight	1,5 mm	420001
	Straight	2,5 mm	420002
	Straight	3,5 mm	420003
	Straight	5 mm	420005
	Angled 7°	1,5 mm	420701
	Angled 7°	3,5 mm	420703
	Angled 7°	5 mm	420705
	Angled 15°	1,5 mm	421501
	Angled 15°	2,5 mm	421502
	Angled 15°	3,5 mm	421503
	Angled 15°	5 mm	421505
	Angled 23°	1,5 mm	422301
	Angled 23°	2,5 mm	422302
	Angled 23°	3,5 mm	422303
	Angled 23°	5 mm	422305









! USE THE MORSE TAPER ABUTMENT REMOVER, if needed. p107



ID^{ALL} Ø3,8 Prosthetic system

Morse Taper & Tube'n'Tube

MORSE TAPER AESTHETIC ABUTMENTS

ANGULATION	TRANSINGIVAL HEIGHT	SHOULDER Ø4	HEALING CAP	SHOULDER Ø5	HEALING CAP
 Straight	1,5 mm	C34001R	R	C35001T	T
 Straight	3,5 mm	C34003S	S	C35003U	U
 Straight	5 mm	C34005S	S	C35005V	V
 Angled 15°	1,5 mm	C34151R	R	C35151T	T
 Angled 15°	3, 5 mm	C34153S	S	C35153U	U
 Angled 15°	5 mm	C34155S	S	C35155V	V
 Angled 23°	1,5 mm	C34231R	R	C35231T	T
 Angled 23°	3,5 mm	C34233S	S	C35233U	U
 Angled 23°	5 mm	C34235S	S	C35235V	V

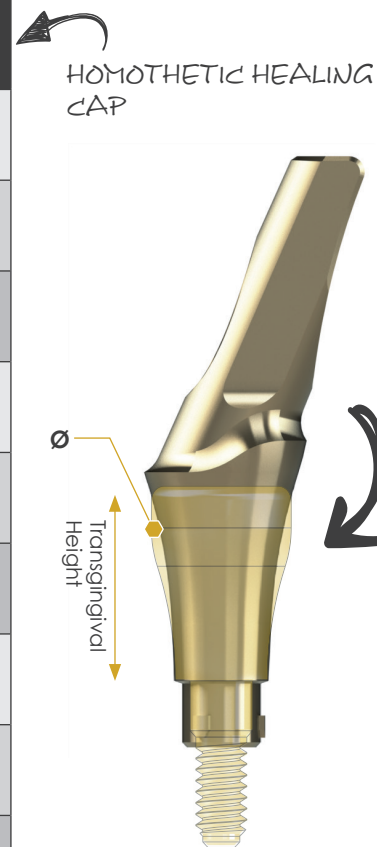

USE THE MORSE TAPER ABUTMENT REMOVER,
if needed.
p107



A QUESTION REGARDING THE AESTHETIC PROSTHETIC SYSTEM ?

Please contact our customer client service,

by phone : **+33 (0)1 48 70 70 48**

or by email : **info@idi-dental.com**





THE SEALED PROSTHESIS

FOR ONE IMPLANT & FOR MULTIPLE IMPLANTS

TUBE'N'TUBE ABUTMENTS

WITH SHOULDER OF Ø5,4 MM		TRANSGINGIVAL HEIGHT	
	Straight	1,5 mm	420011
	Straight	3 mm	420012
	Angled 15°	1,5 mm	421511
	Angled 15°	3 mm	421512
	Angled 23°	1,5 mm	422311
	Angled 23°	3 mm	422312



TUBE'N'TUBE AESTHETIC ABUTMENTS

ANGULATION	TRANSGINGIVAL HEIGHT	Ø4	HEALING CAP	Ø5	HEALING CAP	
	Straight	1,5 mm	T34001R	R	T35001T	T
	Straight	3 mm	T34003S	S	T35003U	U
	Angled 15°	1,5 mm	T34151R	R	T35151T	T
	Angled 15°	3 mm	T34153S	S	T35153U	U
	Angled 23°	1,5 mm	T34231R	R	T35231T	T
	Angled 23°	3 mm	T34233S	S	T35233U	U





HOMEOTHETIC HEALING CAP

ID^{ALL} Ø3,8 Prosthetic system



Morse Taper & Tube 'n' Tube

THE SCREWED PROSTHESIS

FOR ONE IMPLANT

SCANBODY		
	Scanbody CEREC® Bluecam S Type (by 5)	6431295
	Scanbody CEREC® Bluecam L Type (by 5)	6431303
	Scanbody CEREC® Omnicam S Type (by 5)	6431311
	Scanbody CEREC® Omnicam L Type (by 5)	6431329







TIBASE CEREC		
	Titan base for CEREC Ø3,6 mm	7336
	Titan base for CEREC Ø3,1 mm	7436

TRANSGINGIVAL KIT NON-ROTATIONAL		
Ø3,6 MM	TRANSGINGIVAL HEIGHT	
	0,4 mm	6360H
	1,4 mm	6361H
	2,4 mm	6362H

FOR MULTIPLE IMPLANTS



TRANSGINGIVAL KIT ROTATIONAL		
Ø3,6 MM	TRANSGINGIVAL HEIGHT	
	0,4 mm	6360R
	1,4 mm	6361R
	2,4 mm	6362R

BURNOUT CYLINDER		
	Rotational with shoulder of Ø4,8 mm	021801

All the dimensions are in mm.

THE SCREWED PROSTHESIS



FOR MULTIPLE IMPLANTS

IDUNIT SYSTEM

IDUNIT IMPLANT ANALOG



Implant analog

333

IDUNIT IMPRESSION COPYING



Closed tray technique

321



pick-up

322



pick-up Long

322L

IDUNIT RETAINING SCREWS



For prosthetic elements 334 and 336. Maximum **15 N.cm**

0216

IDUNIT BURNOUT CYLINDER



IDUnit Burnout element + screw p/n 0216

336S

IDUNIT TEMPORARY CYLINDER



for IDUNIT + screw P/N : 0216

334

IDUNIT HEALING CAP



for IDUNIT

330

IDUNIT ABUTMENTS

ANGULATION

TRANSGINGIVAL HEIGHT

	Straight	1 mm	U3601
	Straight	2,5 mm	U3602
	Straight	4 mm	U3604
	Straight	6 mm	U3606
	Angled 17°	1 mm	U3621
	Angled 17°	3 mm	U3623
	Angled 17°	5 mm	U3625
	Angled 30°	1 mm	U3631
	Angled 30°	3 mm	U3633
	Angled 30°	5 mm	U3635



ID^{ALL} Ø3,8 Prosthetic system





Morse Taper & Tube'n'Tube

THE REMOVABLE PROSTHESIS





SPHERICAL ATTACHMENTS

	Transgingival height 1 mm	222361
	Transgingival height 2,5 mm	222362
	Transgingival height 4 mm	222364
	Transgingival height 6 mm	222366

BOXES FOR SPHERICAL ATTACHMENTS

	O'ring height:3,5mm Ø external 5mm	0122
	Nitrile retaining ring soft (white)	0120NB
	O'ring retaining ring for O'ring attachment <i>medium</i> (red)	0120SR
	O'ring retaining ring for O'ring attachment <i>strong</i> (black)	0120NN

THE BURNOUT ELEMENTS

	Spherical attachments	9222
	Paralleling guide for burnout spherical attachments	9223
	Burnout connector bar by 3	0931
	Nylon cap	0025

IDLOC SYSTEM

IDLOC IMPLANT ANALOG

	Implant analog	433
--	----------------	-----

IDLOC IMPRESSION COPYING

	Plastic	432
--	---------	-----

IDLOC ATTACHMENT BOX

	Female part (Locator) Thickness 2,5mm	LOCFEM
--	---	--------

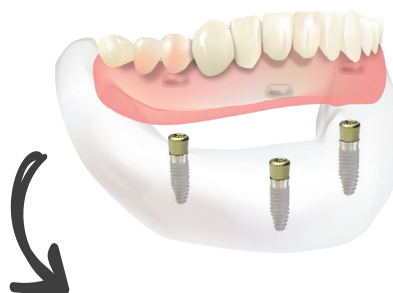

IDLOC ATTACHMENTS

	Transgingival height 1 mm	L3601
	Transgingival height 2,5 mm	L3602
	Transgingival height 4 mm	L3604
	Transgingival height 6 mm	L3606

All the dimensions are in mm.

The Morse Taper

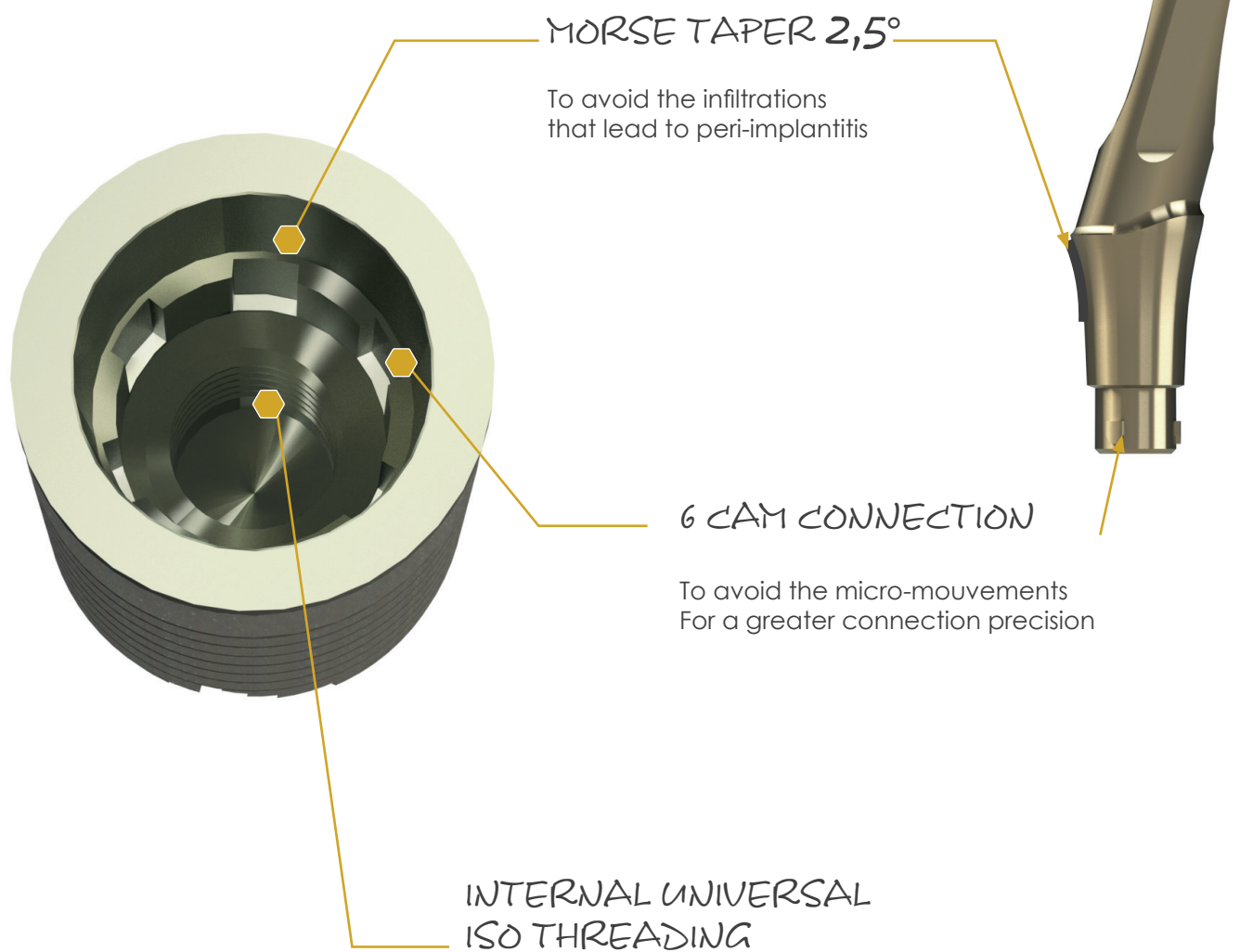
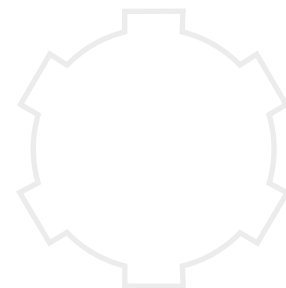

The principle of the Morse Taper was invented by Stephen Morse in the 1860's for the industry.



Features :

- A taper less than 3° for a 5 to 6 times greater friction.
- A "cold welding".









Advantages :



- An optimal barrier against bacteria.
- A significant reduction of the micro-mouvements (the retaining screw is less solicited).
- An increased prosthetic stability.

ID^{ALL} Ø4,2 Prosthetic system





Morse Taper & Tube'n'Tube

→ PROSTHETIC COMPONENTS

IMPRESSION CYLINDER NON-ROTATIONAL		
	Pick-up technique	2004
	Closed tray technique	2004F
	Closed tray technique, long	2004FL
	Pick-up technique, narrow	2004N
	Closed tray technique, narrow long	2004NL
	Pick-up technique Plastic	2004P

IMPRESSION CYLINDER ROTATIONAL		
	Conical	0220C
	Rotational	0221
	Rotational long, special post-extractional	0221L

IMPLANT ANALOG		
	Implant analog Ø4,2 mm	0224

RETAINING SCREWS		
	Retaining screw for tapped screw-retained elements 25N.cm maximum	0211
	Retaining screw for ID ^{CAM} and ID ^{ALL} 25N.cm maximum	0214
	Long head screw for laboratory for all ranges, 25N.cm maximum	0217
	Short head, 25N.cm maximum	0219

→ THE TEMPORARY PROSTHESIS

TITAN ABUTMENTS FOR A TEMPORARY TOOTH FOR ONE IMPLANT RESTORATION		
	Non-rotational - Ø3,6 mm	0206
	Temporary titan abutment, long (post-extractional for switching platform)	0206L









TITAN ABUTMENTS FOR A TEMPORARY TOOTH FOR MULTIPLE IMPLANTS RESTORATION		
	Rotational - Ø3,6 mm	0208
	Temporary titan abutment, long (post-extractional for switching platform)	0208L

All the dimensions are in mm.



THE SEALED PROSTHESIS

↪ FOR ONE IMPLANT

MORSE TAPER ABUTMENTS			
WITH SHOULDER OF Ø5,4 MM		TRANSGINGIVAL HEIGHT	
	Straight	1,5 mm	420001
	Straight	2,5 mm	420002
	Straight	3,5 mm	420003
	Straight	5 mm	420005
	Angled 7°	1,5 mm	420701
	Angled 7°	3,5 mm	420703
	Angled 7°	5 mm	420705
	Angled 15°	1,5 mm	421501
	Angled 15°	2,5 mm	421502
	Angled 15°	3,5 mm	421503
	Angled 15°	5 mm	421505
	Angled 23°	1,5 mm	422301
	Angled 23°	2,5 mm	422302
	Angled 23°	3,5 mm	422303
	Angled 23°	5 mm	422305







USE THE MORSE TAPER ABUTMENT REMOVER, if needed.
p107



ID^{ALL} Ø4,2 Prosthetic system

Morse Taper & Tube'n'Tube

MORSE TAPER AESTHETIC ABUTMENTS

ANGULATION		TRANSGINGIVAL HEIGHT	SHOULDER Ø4	HEALING CAP	SHOULDER Ø5	HEALING CAP
	Straight	1,5 mm	C34001R	R	C35001T	T
	Straight	3,5 mm	C34003S	S	C35003U	U
	Straight	5 mm	C34005S	S	C35005V	V
	Angled 15°	1,5 mm	C34151R	R	C35151T	T
	Angled 15°	3,5 mm	C34153S	S	C35153U	U
	Angled 15°	5 mm	C34155S	S	C35155V	V
	Angled 23°	1,5 mm	C34231R	R	C35231T	T
	Angled 23°	3,5 mm	C34233S	S	C35233U	U
	Angled 23°	5 mm	C34235S	S	C35235V	V

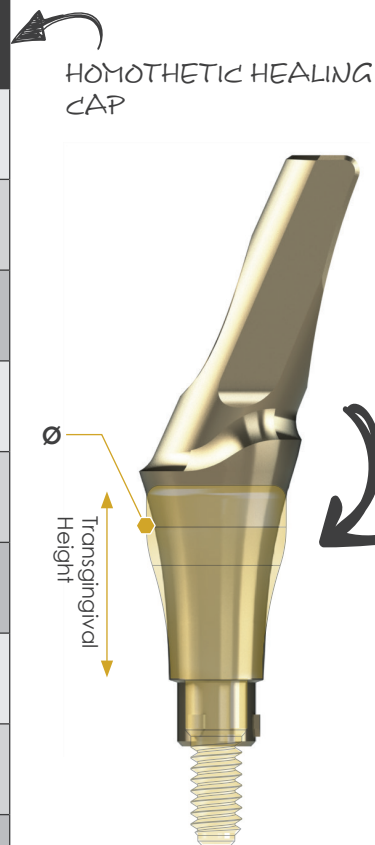

FOR ONE IMPLANT
&
FOR MULTIPLE
IMPLANTS

TUBE'N'TUBE ABUTMENTS

	WITH SHOULDER OF Ø5,4 MM	T.H.*	PLATFORM Ø3,6	PLATFORM Ø4,2
	Straight	1,5 mm	420011	420021
	Straight	3 mm	420012	420022
	Angled 15°	1,5 mm	421511	421521
	Angled 15°	3 mm	421512	421522
	Angled 23°	1,5 mm	422311	422321
	Angled 23°	3 mm	422312	422322

*T.H. : Transgingival Height

All the dimensions are in mm.

THE SEALED PROSTHESIS



TUBE'N'TUBE AESTHETIC ABUTMENTS PLATFORM Ø3,6

ANGULATION	TRANSGINGIVAL HEIGHT	SHOULDER Ø4	HEALING CAP	SHOULDER Ø5	HEALING CAP
 Straight	1,5 mm	T34001R	R	T35001T	T
 Straight	3 mm	T34003S	S	T35003U	U
 Angled 15°	1,5 mm	T34151R	R	T35151T	T
 Angled 15°	3 mm	T34153S	S	T35153U	U
 Angled 23°	1,5 mm	T34231R	R	T35231T	T
 Angled 23°	3 mm	T34233S	S	T35233U	U

TUBE'N'TUBE AESTHETIC ABUTMENTS PLATFORM Ø4,2

ANGULATION	TRANSGINGIVAL HEIGHT	SHOULDER Ø5	HEALING CAP
 Straight	1,5 mm	T45001X	X
 Straight	3 mm	T45003W	W
 Angled 15°	1,5 mm	T45151X	X
 Angled 15°	3 mm	T45153W	W
 Angled 23°	1,5 mm	T45231X	X
 Angled 23°	3 mm	T45233W	W

→ HOMOTHETIC HEALING CAP

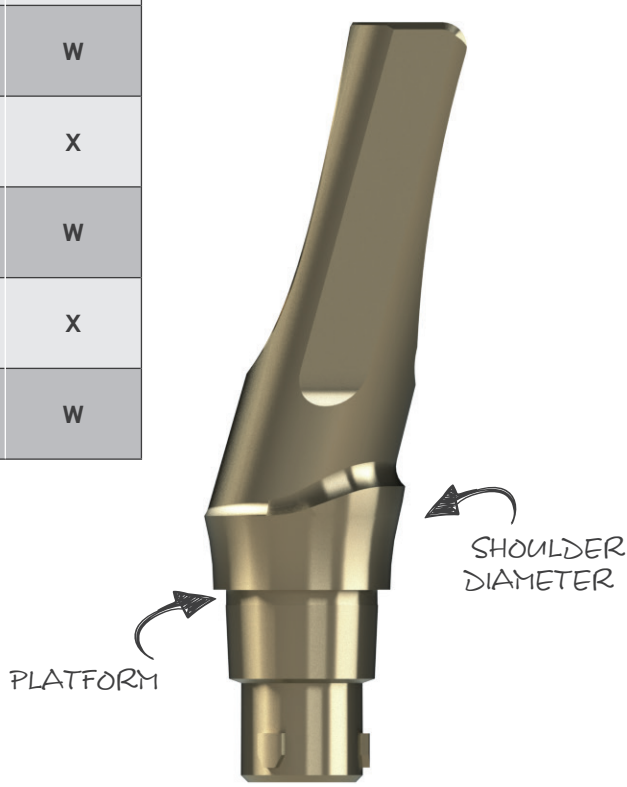





ID^{ALL} Ø4,2 Prosthetic system



Morse Taper & Tube 'n' Tube



THE SCREWED PROSTHESIS

FOR ONE IMPLANT



SCANBODY		
	Scanbody CEREC® Bluecam S Type (by 5)	6431295
	Scanbody CEREC® Bluecam L Type (by 5)	6431303
	Scanbody CEREC® Omnicam S Type (by 5)	6431311
	Scanbody CEREC® Omnicam L Type (by 5)	6431329



TIBASE CEREC		
	Titan base for CEREC Ø4,2 mm	7342
	Titan base for CEREC Ø3,6 mm	7336
	Titan base for CEREC Ø3,1 mm	7436

TRANSGINGIVAL KIT NON-ROTATIONAL		
Ø4,2 MM	TRANSGINGIVAL HEIGHT	
	0,4 mm	6420H
	1,4 mm	6421H
	2,4 mm	6422H

FOR MULTIPLE IMPLANTS

TRANSGINGIVAL KIT ROTATIONAL		
Ø4,2 MM	TRANSGINGIVAL HEIGHT	
	0,4 mm	6420R
	1,4 mm	6421R
	2,4 mm	6422R



BURNOUT CYLINDER		
	Rotational with shoulder of Ø4,8 mm	021801

All the dimensions are in mm.

THE SCREWED PROsthESIS





FOR MULTIPLE IMPLANTS

IDUNIT SYSTEM

IDUNIT IMPLANT ANALOG

	Implant analog	333
---	----------------	-----

IDUNIT IMPRESSION COPYING

	Closed tray technique	321
	pick-up	322
	pick-up Long	322L

IDUNIT RETAINING SCREWS

	For prosthetic elements 334 and 336. Maximum 15 N.cm	0216
---	---	------

IDUNIT BURNOUT CYLINDER

	IDUnit Burnout element + screw P/N : 0216	336S
---	---	------

IDUNIT TEMPORARY CYLINDER

	For IDUNIT + screw P/N : 0216	334
---	-------------------------------	-----

IDUNIT HEALING CAP

	for IDUNIT	330
---	------------	-----

IDUNIT ABUTMENTS

ANGULATION	T.H.*	PL. Ø3,6	PL. Ø4,2
 Straight	1 mm	U3601	U4201
 Straight	2,5 mm	U3602	U4202
 Straight	4 mm	U3604	U4204
 Straight	6 mm	U3606	U4206
 Angled 17°	1 mm	U3621	U4221
 Angled 17°	3 mm	U3623	U4223
 Angled 17°	5 mm	U3625	U4225
 Angled 30°	1 mm	U3631	U4231
 Angled 30°	3 mm	U3633	U4233
 Angled 30°	5 mm	U3635	U4235

*H.T. : Transgingival Height

*PL. : Platform



ID^{ALL} Ø4,2 Prosthetic system





Morse Taper & Tube 'n' Tube

THE REMOVABLE PROSTHESIS

SPHERICAL ATTACHMENTS

	Transgingival height 1 mm	222421
	Transgingival height 2,5 mm	222422
	Transgingival height 4 mm	222424
	Transgingival height 6 mm	222426

THE BURNOUT ELEMENTS

	Spherical attachments	9222
	Paralleling guide for burnout spherical attachments	9223
	Burnout connector bar by 3	0931
	Nylon cap	0025

IDLOC SYSTEM

IDLOC IMPLANT ANALOG

	Implant analog	433
--	----------------	-----

IDLOC IMPRESSION COPYING

	Plastic	432
--	---------	-----

IDLOC ATTACHMENT BOX



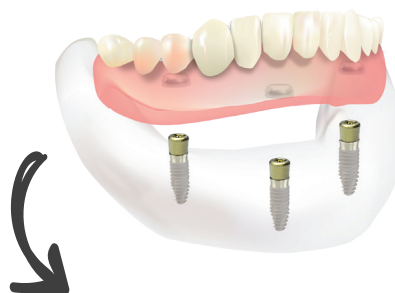

	Female part (Locator) Thickness 2,5mm	LOCFEM
--	---	--------

BOXES FOR SPHERICAL ATTACHMENTS

	O'ring height:3,5mm Ø external 5mm	0122
	Nitrile retaining ring <i>soft</i> (white)	0120NB
	O'ring retaining ring for O'ring attachment <i>medium</i> (red)	0120SR
	O'ring retaining ring for O'ring attachment <i>strong</i> (black)	0120NN



IDLOC ATTACHMENTS

ANGULATION	H.T.*	PL. Ø3,6	PL. Ø4,2
 Straight	1 mm	L3601	L4201
 Straight	2,5 mm	L3602	L4202
 Straight	4 mm	L3604	L4204
 Straight	6 mm	L3606	L4206

*T.H. : Transgingival height

*PL. : Platform

All the dimensions are in mm.

The Platform switching >>>

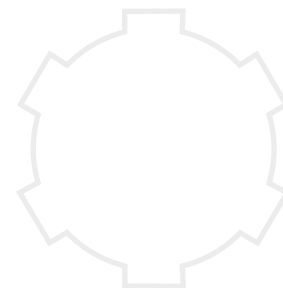

By the implant loading while the prosthesis is inserted, **the periodontal biological space reshapes**, similar to the gum around the natural tooth. This phenomenon leads to a marginal bone loss around the implant neck.

With this finding, the notion of Platform Switching appeared. This enables to consider the creation of a periodontal biological space. The IDALL implant integrates this notion : the healing caps, the impression copyings and the prosthetic abutments are narrower than the implant neck.

↳ This makes it possible for the biological space to develop on both the flat part of the implant neck and on the marginal bone. The space left free on the implant neck will lead to a reduced bone loss around the implant when setting up the final prosthesis.

It is possible to use healing caps, impression copyings and abutments of the same diameter as the implant (Matching Platform) but **the ID^{ALL} implant was developed with the intent to favor the Platform Switching technique.**



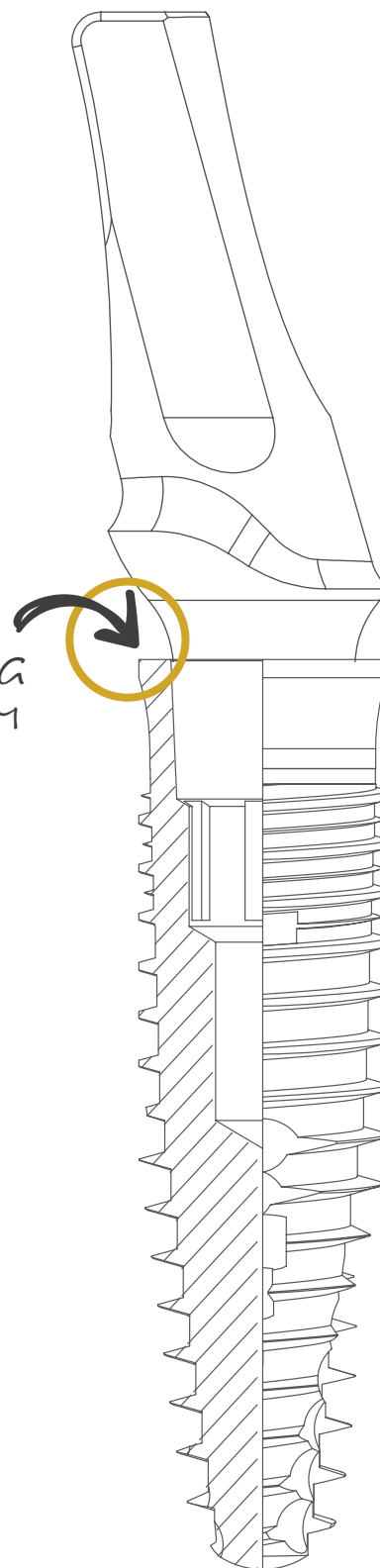



SWITCHING PLATFORM







ID^{ALL} Ø5,2 Prosthetic system





Morse Taper & Tube 'n' Tube

➔ PROSTHETIC COMPONENTS

IMPRESSION CYLINDER NON-ROTATIONAL		
	Pick-up technique	2004
	Closed tray technique	2004F
	Closed tray technique, long	2004FL
	Pick-up technique, narrow	2004N
	Closed tray technique, narrow long	2004NL
	Pick-up technique Plastic	2004P



IMPRESSION CYLINDER ROTATIONAL		
	Conical	0220C
	Rotational	0221
	Rotational long, special post-extractional	0221L

IMPLANT ANALOG		
	Implant analog Ø5,2 mm	0225

RETAINING SCREWS		
	Retaining screw for tapped screw-retained elements 25N.cm maximum	0211
	Retaining screw for ID ^{CAM} and ID ^{ALL} 25N.cm maximum	0214
	Long head screw for laboratory for all ranges, 25N.cm maximum	0217
	Short head, 25N.cm maximum	0219

➔ THE TEMPORARY PROSTHESIS

TITAN ABUTMENTS FOR A TEMPORARY TOOTH FOR ONE IMPLANT RESTORATION		
	Non-rotational - Ø3,6 mm	0206
	Temporary titan abutment, long (post-extractional for switching platform)	0206L

TITAN ABUTMENTS FOR A TEMPORARY TOOTH FOR MULTIPLE IMPLANTS RESTORATION		
	Rotational - Ø3,6 mm	0208
	Temporary titan abutment, long (post-extractional for switching platform)	0208L

All the dimensions are in mm.



THE SEALED PROSTHESIS

↪ FOR ONE IMPLANT

MORSE TAPER ABUTMENTS			
WITH SHOULDER OF Ø5,4 MM		TRANSGINGIVAL HEIGHT	
	Straight	1,5 mm	420001
	Straight	2,5 mm	420002
	Straight	3,5 mm	420003
	Straight	5 mm	420005
	Angled 7°	1,5 mm	420701
	Angled 7°	3, 5 mm	420703
	Angled 7°	5 mm	420705
	Angled 15°	1,5 mm	421501
	Angled 15°	2,5 mm	421502
	Angled 15°	3,5 mm	421503
	Angled 15°	5 mm	421505
	Angled 23°	1,5 mm	422301
	Angled 23°	2,5 mm	422302
	Angled 23°	3,5 mm	422303
	Angled 23°	5 mm	422305











USE THE MORSE TAPER ABUTMENT REMOVER, if needed. p107





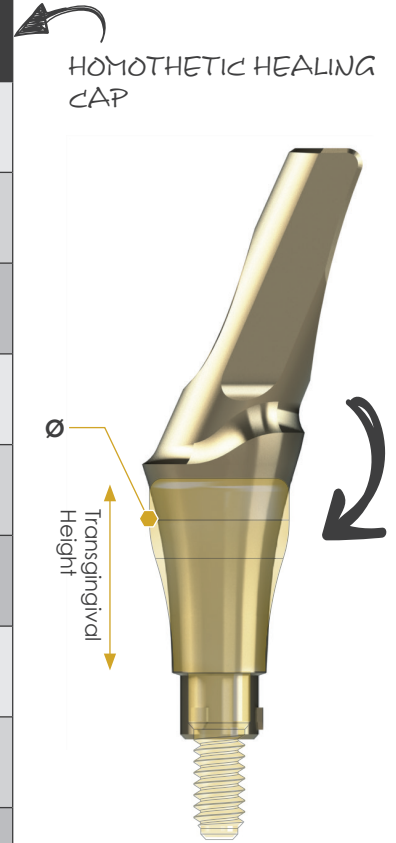

ID^{ALL} Ø5,2 Prosthetic system

Morse Taper & Tube'n'Tube

MORSE TAPER AESTHETIC ABUTMENTS						
ANGULATION		TRANSGINGIVAL HEIGHT	SHOULDER Ø4	HEALING CAP	SHOULDER Ø5	HEALING CAP
	Straight	1,5 mm	C34001R	R	C35001T	T
	Straight	3,5 mm	C34003S	S	C35003U	U
	Straight	5 mm	C34005S	S	C35005V	V
	Angled 15°	1,5 mm	C34151R	R	C35151T	T
	Angled 15°	3,5 mm	C34153S	S	C35153U	U
	Angled 15°	5 mm	C34155S	S	C35155V	V
	Angled 23°	1,5 mm	C34231R	R	C35231T	T
	Angled 23°	3,5 mm	C34233S	S	C35233U	U
	Angled 23°	5 mm	C34235S	S	C35235V	V



FOR ONE IMPLANT
&
FOR MULTIPLE
IMPLANTS







TUBE'N'TUBE ABUTMENTS			SH. Ø5,4	SH. Ø6,2
WITH SHOULDER	T.H.*		PLATFORM Ø4,2	PLATFORM Ø5,2
	Straight	1,5 mm	420021	520021
	Straight	3 mm	420022	520022
	Angled 15°	1,5 mm	421521	521521
	Angled 15°	3 mm	421522	521522
	Angled 23°	1,5 mm	422321	522321
	Angled 23°	3 mm	422322	522322







All the dimensions are in mm.

*H.T. : Transgingival height - SH. : Shoulder

THE SEALED PROSTHESIS



TUBE'N'TUBE AESTHETIC ABUTMENTS			PLATFORM Ø3,6		PL. Ø4,2		PL. Ø5,2		
ANGULATION	T.H.*	SH. Ø4	H. CAP	SH. Ø5	H. CAP	SH. Ø5	H. CAP	SH. Ø6	H. CAP
 Straight	1,5 mm	T34001R	R	T35001T	T	T45001X	X	T56001Y	Y
 Straight	3 mm	T34003S	S	T35003U	U	T45003W	W	T56003Z	Z
 Angled 15°	1,5 mm	T34151R	R	T35151T	T	T45151X	X	T56151Y	Y
 Angled 15°	3 mm	T34153S	S	T35153U	U	T45153W	W	T56153Z	Z
 Angled 23°	1,5 mm	T34231R	R	T35231T	T	T45231X	X	T56231Y	Y
 Angled 23°	3 mm	T34233S	S	T35233U	U	T45233W	W	T56233Z	Z

TUBE'N'TUBE AESTHETIC ABUTMENTS PLATFORM Ø4,2			
ANGULATION	TRANSGINGIVAL HEIGHT	SHOULDER Ø5	H. CAP
 Straight	1,5 mm	T45001X	X
 Straight	3 mm	T45003W	W
 Angled 15°	1,5 mm	T45151X	X
 Angled 15°	3 mm	T45153W	W
 Angled 23°	1,5 mm	T45231X	X
 Angled 23°	3 mm	T45233W	W

→ HOMOTHETIC HEALING CAP

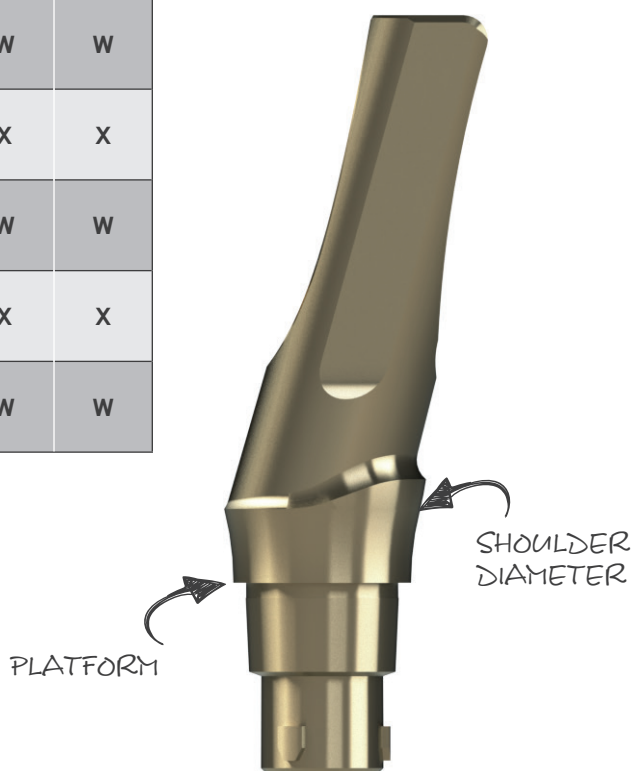





ID^{ALL} Ø5,2 Prosthetic system



Morse Taper & Tube 'n' Tube



THE SCREWED PROSTHESIS

FOR ONE IMPLANT



SCANBODY		
	Scanbody CEREC® Bluecam S Type (by 5)	6431295
	Scanbody CEREC® Bluecam L Type (by 5)	6431303
	Scanbody CEREC® Omnicam S Type (by 5)	6431311
	Scanbody CEREC® Omnicam L Type (by 5)	6431329



TIBASE CEREC		
	Titan base for CEREC Ø4,2 mm	7342
	Titan base for CEREC Ø5,2 mm	7352

TRANSGINGIVAL KIT NON-ROTATIONAL			
	TRANSGINGIVAL HEIGHT	Ø4,2	Ø5,2
	0,4 mm	6420H	6520H
	1,4 mm	6421H	6521H
	2,4 mm	6422H	6522H

FOR MULTIPLE IMPLANTS

TRANSGINGIVAL KIT ROTATIONAL			
	TRANSGINGIVAL HEIGHT	Ø4,2	Ø5,2
	0,4 mm	6420R	6520R
	1,4 mm	6421R	6521R
	2,4 mm	6422R	6522R



BURNOUT CYLINDER		
	Rotational with shoulder of Ø4,8 mm	021801

All the dimensions are in mm.

THE SCREWED PROsthESIS





FOR MULTIPLE IMPLANTS

IDUNIT SYSTEM

IDUNIT IMPLANT ANALOG

	Implant analog	333
---	----------------	-----

IDUNIT IMPRESSION COPYING

	Closed tray technique	321
	pick-up	322
	pick-up Long	322L

IDUNIT RETAINING SCREWS

	For prosthetic elements 334 and 336. Maximum 15 N.cm	0216
---	---	------

IDUNIT BURNOUT CYLINDER

	IDUNIT Burnout element + screw P/N : 0216	336S
---	---	------

IDUNIT TEMPORARY CYLINDER

	For IDUnit + screw P/N : 0216	334
---	-------------------------------	-----

IDUNIT HEALING CAP

	for IDUNIT	330
---	------------	-----

IDUNIT ABUTMENTS

ANGULATION	T.H.*	PL. Ø3,6	PL. Ø4,2	PL. Ø5,2
 Straight	1 mm	U3601	U4201	U5201
 Straight	2,5 mm	U3602	U4202	U5202
 Straight	4 mm	U3604	U4204	U5204
 Straight	6 mm	U3606	U4206	U5206
 Angled 17°	1 mm	U3621	U4221	U5221
 Angled 17°	3 mm	U3623	U4223	U5223
 Angled 17°	5 mm	U3625	U4225	U5225
 Angled 30°	1 mm	U3631	U4231	U5231
 Angled 30°	3 mm	U3633	U4233	U5233
 Angled 30°	5 mm	U3635	U4235	U5235

*T.H. : Transgingival height

*PL. : Platform



ID^{ALL} Ø5,2 Prosthetic system





Morse Taper & Tube'n'Tube

THE REMOVABLE PROSTHESIS





SPHERICAL ATTACHMENTS

	Transgingival height 1 mm	222521
	Transgingival height 2,5 mm	222522
	Transgingival height 4 mm	222524
	Transgingival height 6 mm	222526

BOXES FOR SPHERICAL ATTACHMENTS

	O'ring height:3,5mm Ø external 5mm	0122
	Nitrile retaining ring <i>soft</i> (white)	0120NB
	O'ring retaining ring for O'ring attachment <i>medium</i> (red)	0120SR
	O'ring retaining ring for O'ring attachment <i>strong</i> (black)	0120NN

THE BURNOUT ELEMENTS

	Spherical attachments	9222
	Paralleling guide for burnout spherical attachments	9223
	Burnout connector bar by 3	0931
	Nylon cap	0025

IDLOC SYSTEM

IDLOC IMPLANT ANALOG

	Implant analog	433
--	----------------	-----

IDLOC IMPRESSION COPYING

	Plastic	432
--	---------	-----

IDLOC ATTACHMENT BOX

	Female part (Locator) Thickness 2,5mm	LOCFEM
--	---	--------

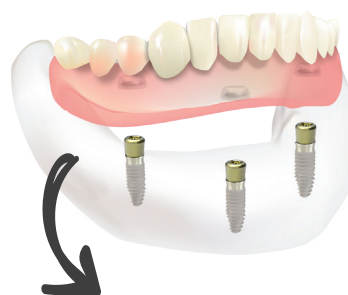





IDLOC ATTACHMENTS

	Transgingival height 1 mm	L5201
	Transgingival height 2,5 mm	L5202
	Transgingival height 4 mm	L5204
	Transgingival height 6 mm	L5206

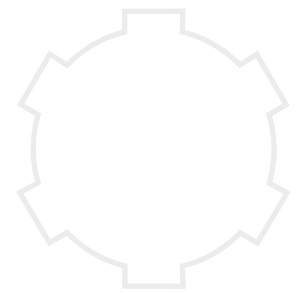
All the dimensions are in mm.



The CAD/CAM for the ID^{ALL} implants





IMPLANT ANALOG		
	Digital repositionable cams Ø3,6 mm	0223N
	Digital repositionable cams Ø4,2 mm	0224N
	Digital repositionable cams Ø5,2 mm	0225N



SCANBODY IN TITAN		
	CAD/CAM impression copying Cam connection	SBCT



PREMILLED ABUTMENT Ø12		
	Conical	PMC12
	Tube'n'Tube	PMP12



PREMILLED ABUTMENT Medentika Type Ø12		
	Conical	PMC12M
	Tube'n'Tube	PMP12M

IDUNIT		
	IDUnit Tibase + screw P/N 0216	TU
	IDUnit CAD/CAM impression copying	321P

TIBASES

CONICAL CONNECTION		
	Height 0,5 mm With screw P/N 0211	TC320
	Height 2 mm With screw P/N 0211	TC322
	Height 4 mm With screw P/N 0211	TC324

TUBE'N'TUBE ROTATIONAL CONNECTION	Ø 3,6 MM	Ø 4,2 MM	Ø 5,2 MM
 Height 0,5 mm With screw P/N 0211	TR360	TR420	TR520
 Height 2 mm With screw P/N 0211	TR362	TR422	TR522
 Height 4 mm With screw P/N 0211	TR364	TR424	TR524

TUBE'N'TUBE CAM CONNECTION	Ø 3,6 MM	Ø 4,2 MM	Ø 5,2 MM
 Height 0,5 mm With screw P/N 0211	TP360	TP420	TP520
 Height 2 mm With screw P/N 0211	TP362	TP422	TP522
 Height 4 mm With screw P/N 0211	TP364	TP424	TP524





**Hexagonal
connection
IMPLANTS**

ID^{BIO}

&

ID^{MAX}

Ranges

Hexagonal connection implant

PRESENTATION

The conception of the ID^{BIO} implant significantly improves the stabilization of the prosthetic restoration thanks to its GSP connection (Groove for Prosthetic Stabilization).

The ID^{BIO} benefits from the S.M.A sandblasted, acid-etched and TiO₂ coated state of surface, from a two-phase Ti6Al4V grade 5.

The ID^{BIO} implant draws special attention to itself thanks to its square and V shaped threads and thanks to its anchorage for prosthetic stabilization. This self-condensing implant stands 75 N.cm screwing stress without being affected.

This implant draws special attention to itself due to its hexagonal prosthetic anchorage and its cylindro-tapered shape like a dental root. Its cylindrical shape at the level of the implant neck reduces the tension at the level of the crestal bone. Its conical shape allows a better insertion between the adjacent teeth. The angulation, the space and the depth of the threads were specially studied to optimize the stabilization in any bone density and favor the immediate loading. Its aggressive apex enables efficient primary catch.

Features of the ID^{BIO} implant :

- Cylindro-tapered-shaped
- Titan alloy two phase Ti6Al4V grade 5
- S.M.A. TiO₂ state of surface
- Hexagonal connection
- Anti-unscrewing groove
- Progressive and condensing threads
- Penetrating apex

Instructions for use :

1. Use the screwdriver P/N 0146, 1046, 0046, 0846 to screw the implant.
2. Use the screwdriver P/N 0014, 1014, 1114, 0114 to screw the cover screw manually at 5 N.cm while omitting the hinged ratchet.

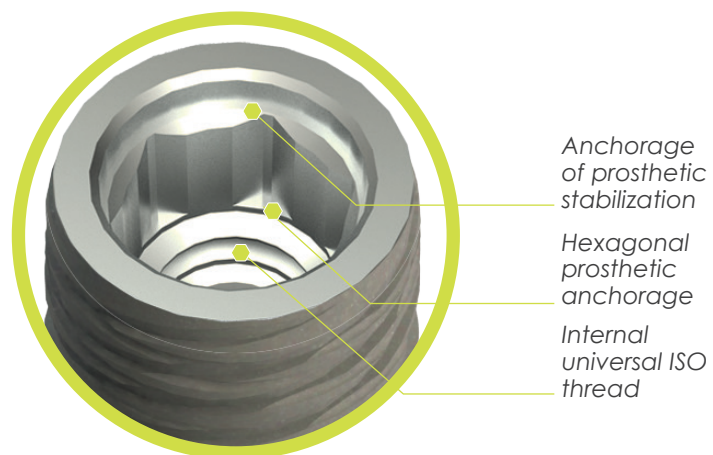
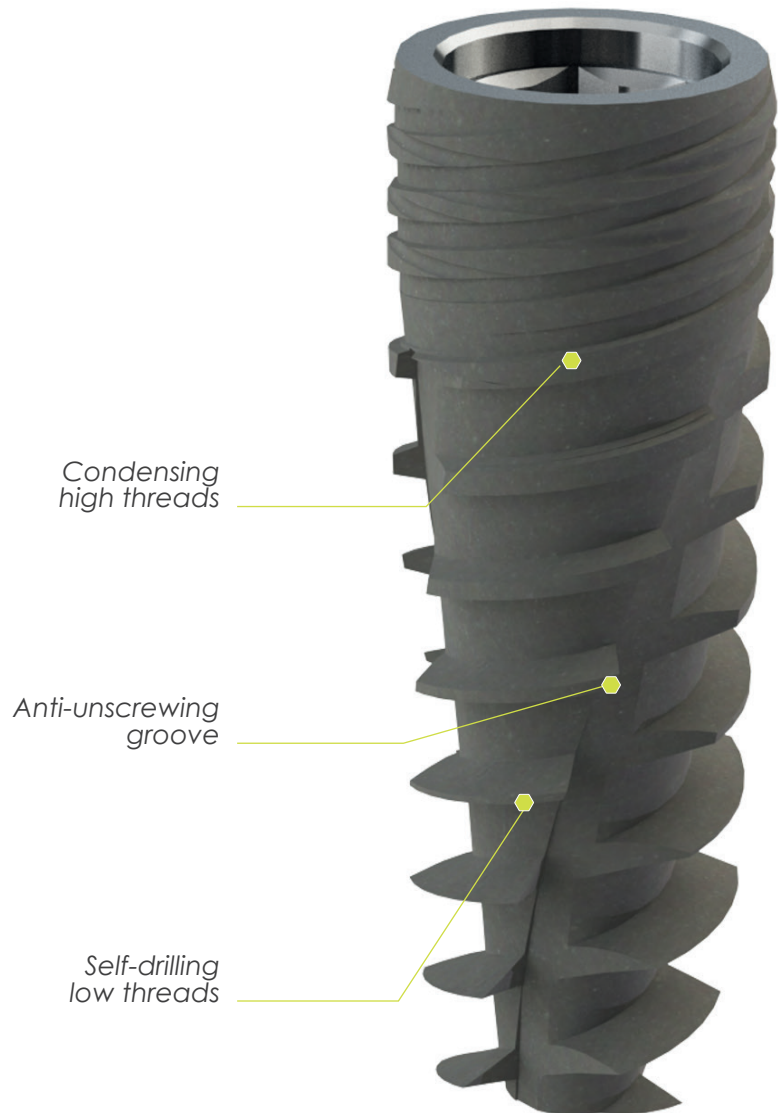

All the dimensions are in mm.

IMPLANT RANGE



LENGTH Color code*	DIAMETER	P/N
8 mm ●	3,5 mm	IDB0835
8 mm ●	4 mm	IDB0840
8 mm ●	5 mm	IDB0850
10 mm ●	3,5 mm	IDB1035
10 mm ●	4 mm	IDB1040
10 mm ●	5 mm	IDB1050
12 mm ●	3,5 mm	IDB1235
12 mm ●	4 mm	IDB1240
12 mm ●	5 mm	IDB1250
15 mm ●	3,5 mm	IDB1535
15 mm ●	4 mm	IDB1540
15 mm ●	5 mm	IDB1550



*On each implant packaging there is a small colored sticker to match with the implant length. The code for each color is related to the one found on the RBS drills for the implants with a hexagonal connection :

- 8 mm length
- 10 mm length
- 12 mm length
- 15 mm length

→ SURGICAL SCREWS

CONICAL HEALING CAP

SCREW	Ø LOW PART	Ø HIGH PART	HEIGHT	IMPLANTS	P/N
	3,5 mm	4,5 mm	4 mm	ID ^{BIO} Ø3,5 mm	1331
	3,5 mm	4,5 mm	6 mm	ID ^{BIO} Ø3,5 mm	1332
	4 mm	5 mm	4 mm	ID ^{BIO} Ø4 mm	1341
	4 mm	5 mm	6 mm	ID ^{BIO} Ø4 mm	1342
	4,9 mm	6 mm	4 mm	ID ^{BIO} Ø5 mm	1351
	4,9 mm	6 mm	6 mm	ID ^{BIO} Ø5 mm	1352

CYLINDRICAL HEALING CAP H.2

SCREW	IMPLANTS	P/N
	ID ^{BIO} Ø3,5 mm	1330
	ID ^{BIO} Ø4 mm	1340
	ID ^{BIO} Ø5 mm	1350

CLOSING CAP

SCREW	IMPLANTS	P/N
	ID ^{BIO} Ø3,5 mm	1231
	ID ^{BIO} Ø4 mm	1241
	ID ^{BIO} Ø5 mm	1251

Non contractual photos and illustrations.

ID^{BIO} IMPLANT

Prosthetic guide



SEALED



**Titan abutment
for TEMPORARY TOOTH
Non-rotational**
 Ø3,5 p58
 Ø4 p62
 Ø5 p66



**Titan abutment
for TEMPORARY TOOTH
Rotational**
 Ø3,5 p58
 Ø4 p62
 Ø5 p66

FOR ONE IMPLANT

FOR MULTIPLE IMPLANTS



**HEXAGONAL
abutments**
 Straight ou Angled
 Ø3,5 p58
 Ø4 p62
 Ø5 p66



**HEXAGONAL
abutments**
 Straight ou Angled
 Ø3,5 p58
 Ø4 p62
 Ø5 p66

REMOVABLE



**Spherical
attachments**
 Ø3,5 p61
 Ø4 p65
 Ø5 p69



**Burnout
spherical
attachments**
 Ø3,5 p61
 Ø4 p65
 Ø5 p69



**IDLoc
Attachments**
 Ø3,5 p61
 Ø4 p65
 Ø5 p69



SCREWED



TEMPORARY titanium cylinder IDUnit
 Ø3,5 p60
 Ø4 p64
 Ø5 p68

FOR ONE IMPLANT

FOR MULTIPLE IMPLANTS

Transgingival Kits
 Non-rotational
 Ø3,5 p59
 Ø4 p63
 Ø5 p67

CEREC Tibase
 Ø3,5 p59
 Ø4 p63
 Ø5 p67

Burnout cylinders
 Non-rotational
 Ø3,5 p59
 Ø4 p63
 Ø5 p67

IDUnit Attachments
 Straight ou Angled
 Ø3,5 p60
 Ø4 p64
 Ø5 p68



Transgingival Kits
 Rotational
 Ø3,5 p59
 Ø4 p63
 Ø5 p67

Burnout cylinders
 Rotational
 Ø3,5 p59
 Ø4 p63
 Ø5 p67

ID^{BIO} Ø3,5 Prosthetic system





Hexagonal

→ PROSTHETIC COMPONENTS

TIMPRESSION COPYINGS NON-ROTATIONAL		
	Closed tray technique	905
	Pick-up technique Ø5 mm	906

TIMPRESSION COPYINGS ROTATIONAL		
	Straight	7210
	Narrow	7211

IMPLANT ANALOG		
	Implant analog For Ø3,5 mm ID ^{BIO} hexagonal implant	2335A

RETAINING SCREWS		
	Retaining screw for tapped screw-retained elements 25 N.cm maximum	0215
	Long head screw for laboratory	0217
	Retaining screw for prosthesis 25 N.cm maximum (short head : Ø2,5mm)	1413
	Retaining screw for prosthesis 25 N.cm maximum	1414

→ THE TEMPORARY PROSTHESIS

TITAN ABUTMENTS FOR A TEMPORARY TOOTH FOR ONE IMPLANT RESTORATION		
	Non-rotational - Ø3,5 mm	APPH35

TITAN ABUTMENTS FOR A TEMPORARY TOOTH FOR MULTIPLE IMPLANTS RESTORATION		
	Rotational - Ø3,5 mm	APPR35

THE SEALED PROSTHESIS

↪ FOR ONE IMPLANT
&
FOR MULTIPLE
IMPLANTS

HEXAGONAL ABUTMENTS				
	DIAMETER	DESCRIPTION	LENGTH	
	Ø3,4 mm	Straight slim for switching platform	10 mm	3400G
	Ø3,5 mm	Straight	10 mm	3600G
	Ø3,5 mm	Straight shoulder 2 mm	10 mm	3602G
	Ø3,5 mm	Straight shoulder 4 mm	12 mm	3604G
	Ø3,5 mm	Angled 15°	10 mm	3615G
	Ø3,5 mm	Angled 23°	10 mm	3623G
	Ø3,5 mm	from 0° to 18°		HTU1G

All the dimensions are in mm.



THE SCREWED PROSTHESIS

FOR ONE IMPLANT

TIBASE CEREC		
	Titan base for CEREC Ø3,5 mm	7335

SCANBODY		
	Scanbody CEREC® Bluecam S Type (by 5)	6431295
	Scanbody CEREC® Bluecam L Type (by 5)	6431303
	Scanbody CEREC® Omnicam S Type (by 5)	6431311
	Scanbody CEREC® Omnicam L Type (by 5)	6431329

TRANSGINGIVAL KITS NON-ROTATIONAL		
Ø3,5 MM	TRANSGINGIVAL HEIGHT	
	0,5 mm	6350H
	1,5 mm	6351H
	2,5 mm	6352H

BURNOUT CYLINDER		
	Non-rotational + retaining screw P/N : 1414	356S

FOR MULTIPLE IMPLANTS

BURNOUT CYLINDER		
	Rotational + retaining screw P/N : 1414	358S

TRANSGINGIVAL KITS ROTATIONAL		
Ø3,5 MM	TRANSGINGIVAL HEIGHT	
	0,5 mm	6350R
	1,5 mm	6351R
	2,5 mm	6352R

ID^{BIO}Ø3,5 Prosthetic system

Hexagonal

THE SCREWED PROSTHESIS





IDUNIT SYSTEM

IDUNIT IMPLANT ANALOG

	Implant analog	333
--	----------------	-----

IDUNIT IMPRESSION COPYINGS

	Closed tray technique	321
	Pick up technique	322
	Pick up technique long	322L

IDUNIT RETAINING SCREWS

	For prosthetic elements 334 and 336. Maximum 15 N. cm	0216
--	--	------

IDUNIT BURNOUT CYLINDER

	IDUnit burnout element + screw P/N : 0216	336S
--	--	------

IDUNIT TEMPORARY TITANIUM CYLINDER

	For IDUnit + screw P/N : 0216	334
--	-------------------------------	-----

IDUNIT HEALING CAP

	For IDUnit	330
--	------------	-----

IDUNIT ABUTMENTS

	ANGULATION	TRANSGINGIVAL HEIGHT	
	Straight	1 mm	U3501
	Straight	2,5 mm	U3502
	Straight	4 mm	U3504
	Straight	6 mm	U3506
	Angled 17°	1 mm	U3521
	Angled 30°	1 mm	U3531









All the dimensions are in mm.



THE REMOVABLE PROSTHESIS

SPHERICAL ATTACHMENTS		
	Transgingival height 1 mm	222351
	Transgingival height 2,5 mm	222352
	Transgingival height 4 mm	222354
	Transgingival height 6 mm	222356

BOXES FOR SPHERICAL ATTACHMENTS		
	O'ring height:3,5mm Ø external 5mm	0122
	Nitrile retaining ring <i>soft</i> (white)	0120NB
	O'ring retaining ring for O'ring attachment <i>medium</i> (red)	0120SR
	O'ring retaining ring for O'ring attachment <i>strong</i> (black)	0120NN

THE BURNOUT ELEMENTS		
	Spherical attachments	9222
	Paralleling guide for burnout spherical attachments	9223
	Burnout connector bar by 3	0931
	Nylon cap	0025

IDLOC SYSTEM

IDLOC IMPLANT ANALOG		
	Implant analog	433

IDLOC IMPRESSION COPYING		
	Plastic	432

IDLOC ATTACHMENT BOX		
	Female part (Locator) Thickness 2,5mm	LOCFEM

IDLOC ATTACHMENTS		
	Transgingival height 1 mm	L3501
	Transgingival height 2,5 mm	L3502
	Transgingival height 4 mm	L3504
	Transgingival height 6 mm	L3506

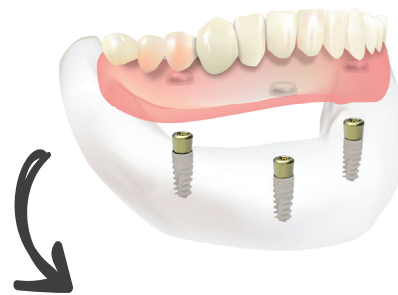

ID^{BIO} Ø4 Prosthetic system





Hexagonal

→ PROSTHETIC COMPONENTS

IMPRESSION COPYINGS NON-ROTATIONAL		
	Closed tray technique	905
	Pick-up technique Ø5 mm	906

IMPRESSION COPYINGS ROTATIONAL		
	Straight	7210
	Narrow	7211

IMPLANT ANALOG		
	For Ø4 mm ID ^{BIO} hexagonal implant	2340A

RETAINING SCREWS		
	Retaining screw for tapped screw-retained elements 25 N.cm maximum	0215
	Long head screw for laboratory	0217
	Retaining screw for prosthesis 25 N.cm maximum (short head : Ø2,5mm)	1413
	Retaining screw for prosthesis 25 N.cm maximum	1414

→ THE TEMPORARY PROSTHESIS

TITAN ABUTMENTS FOR A TEMPORARY TOOTH FOR ONE IMPLANT RESTORATION		
	Non-rotational - Ø4 mm	APPH40

TITAN ABUTMENTS FOR A TEMPORARY TOOTH FOR MULTIPLE IMPLANTS RESTORATION		
	Rotational - Ø4 mm	APPR40

THE SEALED PROSTHESIS

↪ FOR ONE IMPLANT
&
FOR MULTIPLE
IMPLANTS

HEXAGONAL ABUTMENTS				
	DIAMETER	DESCRIPTION	LENGTH	
	Ø3,8 mm	Straight for Platform switching	10 mm	3800G
	Ø4 mm	Straight	10 mm	4000G
	Ø4 mm	Straight shoulder 2 mm	10 mm	4002G
	Ø4 mm	Straight shoulder 4 mm	12 mm	4004G
	Ø4 mm	Angled 15°	10 mm	4015G
	Ø4 mm	Angled 23°	10 mm	4023G
	Ø4 mm	from 0° to 18°		HTU2G





All the dimensions are in mm.





THE SCREWED PROSTHESIS

↪ FOR ONE IMPLANT

TIBASE CEREC		
	Titan base for CEREC Ø4 mm	7340



SCANBODY		
	Scanbody CEREC® Bluecam S Type (by 5)	6431295
	Scanbody CEREC® Bluecam L Type (by 5)	6431303
	Scanbody CEREC® Omnicam S Type (by 5)	6431311
	Scanbody CEREC® Omnicam L Type (by 5)	6431329

TRANSGINGIVAL KITS NON-ROTATIONAL		
Ø4 MM	TRANSGINGIVAL HEIGHT	
	0,5 mm	6400H
	1,5 mm	6401H
	2,5 mm	6402H

BURNOUT CYLINDER		
	Non-rotational + retaining screw P/N : 1414	456S

↪ FOR MULTIPLE IMPLANTS

BURNOUT CYLINDER		
	Rotational + retaining screw P/N : 1414	458S

TRANSGINGIVAL KITS ROTATIONAL		
Ø4 MM	TRANSGINGIVAL HEIGHT	
	0,5 mm	6400R
	1,5 mm	6401R
	2,5 mm	6402R

Hexagonal

THE SCREWED PROSTHESIS





IDUNIT SYSTEM

IDUNIT IMPLANT ANALOG

	Implant analog	333
--	----------------	-----

IDUNIT IMPRESSION COPYINGS

	Closed tray technique	321
	Pick up technique	322
	Pick up technique long	322L

IDUNIT RETAINING SCREWS

	For prosthetic elements 334 and 336. Maximum 15 N. cm	0216
--	--	------

IDUNIT BURNOUT CYLINDER

	IDUnit burnout element + screw P/N : 0216	336S
--	--	------





IDUNIT TEMPORARY TITANIUM CYLINDER

	For IDUnit + screw P/N : 0216	334
--	-------------------------------	-----

IDUNIT HEALING CAP

	For IDUnit	330
--	------------	-----

IDUNIT ABUTMENTS

	ANGULATION	TRANSGINGIVAL HEIGHT	
	Straight	1 mm	U4001
	Straight	2,5 mm	U4002
	Straight	4 mm	U4004
	Straight	6 mm	U4006
	Angled 17°	1 mm	U4121
	Angled 30°	1 mm	U4131









THE REMOVABLE PROSTHESIS





SPHERICAL ATTACHMENTS

	Transgingival height 1 mm	222401
	Transgingival height 2,5 mm	222402
	Transgingival height 4 mm	222404
	Transgingival height 6 mm	222406

BOXES FOR SPHERICAL ATTACHMENTS

	O'ring height: 3,5mm Ø external 5mm	0122
	Nitrile retaining ring soft (white)	0120NB
	O'ring retaining ring for O'ring attachment <i>medium</i> (red)	0120SR
	O'ring retaining ring for O'ring attachment <i>strong</i> (black)	0120NN

THE BURNOUT ELEMENTS

	Spherical attachments	9222
	Paralleling guide for burnout spherical attachments	9223
	Burnout connector bar by 3	0931
	Nylon cap	0025

IDLOC SYSTEM

IDLOC IMPLANT ANALOG

	Implant analog	433
---	----------------	-----

IDLOC IMPRESSION COPYING

	Plastic	432
---	---------	-----

IDLOC ATTACHMENT BOX

	Female part (Locator) Thickness 2,5mm	LOCFEM
---	---	--------

IDLOC ATTACHMENTS

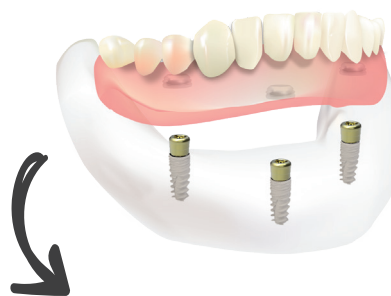

	Transgingival height 1 mm	L4001
	Transgingival height 2,5 mm	L4002
	Transgingival height 4 mm	L4004
	Transgingival height 6 mm	L4006



ID^{BIO}Ø5 Prosthetic system





Hexagonal

→ PROSTHETIC COMPONENTS

IMPRESSION COPYINGS NON-ROTATIONAL		
	Closed tray technique	905
	Pick-up technique Ø5 mm	906

IMPRESSION COPYINGS ROTATIONAL		
	Straight	7210
	Narrow	7211

IMPLANT ANALOG		
	For Ø5 mm ID ^{BIO} hexagonal implant	2350A

RETAINING SCREWS		
	Retaining screw for tapped screw-retained elements 25 N.cm maximum	0215
	Long head screw for laboratory	0217
	Retaining screw for prosthesis 25 N.cm maximum (short head : Ø2,5mm)	1413
	Retaining screw for prosthesis 25 N.cm maximum	1414

→ THE TEMPORARY PROSTHESIS

TITAN ABUTMENTS FOR A TEMPORARY TOOTH FOR ONE IMPLANT RESTORATION		
	Non-rotational - Ø5 mm	APPH50

TITAN ABUTMENTS FOR A TEMPORARY TOOTH FOR MULTIPLE IMPLANTS RESTORATION		
	Rotational - Ø5 mm	APPR50

THE SEALED PROSTHESIS

↪ FOR ONE IMPLANT
&
FOR MULTIPLE
IMPLANTS

HEXAGONAL ABUTMENTS				
	DIAMETER	DESCRIPTION	LENGTH	
	Ø5 mm	Straight	10 mm	5000G
	Ø5 mm	Straight shoulder 2 mm	10 mm	5002G
	Ø5 mm	Straight shoulder 4 mm	12 mm	5004G
	Ø5 mm	Angled 15°	10 mm	5015G
	Ø5 mm	Angled 23°	10 mm	5023G
	Ø5 mm	from 0° to 18°		HTU5G





All the dimensions are in mm.





THE SCREWED PROSTHESIS

FOR ONE IMPLANT

TIBASE CEREC		
	Titan base for CEREC Ø5 mm	7350



SCANBODY		
	Scanbody CEREC® Bluecam S Type (by 5)	6431295
	Scanbody CEREC® Bluecam L Type (by 5)	6431303
	Scanbody CEREC® Omnicam S Type (by 5)	6431311
	Scanbody CEREC® Omnicam L Type (by 5)	6431329

TRANSGINGIVAL KITS NON-ROTATIONAL		
Ø5 MM	TRANSGINGIVAL HEIGHT	
	0,5 mm	6500H
	1,5 mm	6501H
	2,5 mm	6502H

BURNOUT CYLINDER		
	Non-rotational + retaining screw P/N : 1414	556S

FOR MULTIPLE IMPLANTS

BURNOUT CYLINDER		
	Rotational + retaining screw P/N : 1414	558S

TRANSGINGIVAL KITS ROTATIONAL		
Ø5 MM	TRANSGINGIVAL HEIGHT	
	0,5 mm	6500R
	1,5 mm	6501R
	2,5 mm	6502R

Hexagonal

THE SCREWED PROSTHESIS





IDUNIT SYSTEM

IDUNIT IMPLANT ANALOG

	Implant analog	333
--	----------------	-----

IDUNIT IMPRESSION COPYINGS

	Closed tray technique	321
	Pick up technique	322
	Pick up technique long	322L

IDUNIT RETAINING SCREWS

	For prosthetic elements 334 and 336. Maximum 15 N. cm	0216
--	--	------

IDUNIT BURNOUT CYLINDER

	IDUnit burnout element + screw P/N : 0216	336S
--	--	------







IDUNIT TEMPORARY TITANIUM CYLINDER

	For IDUnit + screw P/N : 0216	334
--	-------------------------------	-----

IDUNIT HEALING CAP

	For IDUnit	330
--	------------	-----

IDUNIT ABUTMENTS



	ANGULATION	TRANSGINGIVAL HEIGHT	
	Straight	1 mm	U5001
	Straight	2,5 mm	U5002
	Straight	4 mm	U5004
	Straight	6 mm	U5006
	Angled 17°	1 mm	U5021
	Angled 30°	1 mm	U5031









THE REMOVABLE PROSTHESIS

SPHERICAL ATTACHMENTS		
	Transgingival height 1 mm	222501
	Transgingival height 2,5 mm	222502
	Transgingival height 4 mm	222504
	Transgingival height 6 mm	222506

BOXES FOR SPHERICAL ATTACHMENTS		
	O'ring height: 3,5mm Ø external 5mm	0122
	Nitrile retaining ring soft (white)	0120NB
	O'ring retaining ring for O'ring attachment <i>medium</i> (red)	0120SR
	O'ring retaining ring for O'ring attachment <i>strong</i> (black)	0120NN



THE BURNOUT ELEMENTS		
	Spherical attachments	9222
	Paralleling guide for burnout spherical attachments	9223
	Burnout connector bar by 3	0931
	Nylon cap	0025

IDLOC SYSTEM

IDLOC IMPLANT ANALOG		
	Implant analog	433

IDLOC IMPRESSION COPYING		
	Plastic	432

IDLOC ATTACHMENT BOX		
	Female part (Locator) Thickness 2,5mm	LOCFEM

IDLOC ATTACHMENTS		
	Transgingival height 1 mm	L5001
	Transgingival height 2,5 mm	L5002
	Transgingival height 4 mm	L5004
	Transgingival height 6 mm	L5006

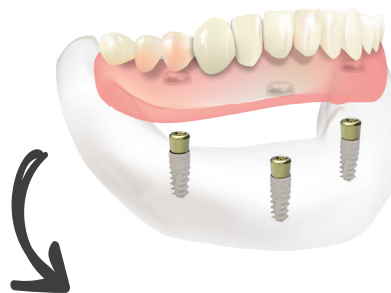

Hexagonal connection implant

PRESENTATION

The ID^{MAX} benefits from the S.M.A sandblasted, acid-etched and TiO₂ coated state of surface, from a two-phase Ti6Al4V grade 5.

Its cylindro-tapered shape has a hexagonal prosthetic anchorage.

Its splayed neck avoids accidental implant over insertion. The aesthetic gold-polished provides a better transgingival aspect.

It is highly appreciated for safety sinus lifting.

Instructions for use :

IDMAX 4

1. Last drill in the sequence: diameter 3.5 mm
2. Omit the profile drill stage
3. Use a hexagonal screwdriver P/N 1146, 1046, 0146, 0046, to insert the implant
4. The ID^{MAX} 4 type implants can be set using the one-step, the one and half step or the two-step technique.
5. With poorly mineralized bone the last drill is only inserted up to a third of its length
6. Use the manual thread tap P/N TAR4

IDMAX 5

1. Last drill in the sequence: diameter 4 mm
2. Omit the profile drill stage
3. Use a hexagonal screwdriver P/N 1146, 1046, 0146, 0046, to insert the implant
4. The ID^{MAX} 5 type implants can be set using the one-step, the one and half step or the two-step technique.
5. With poorly mineralized bone the last drill is only inserted up to a third of its length
6. Use the manual thread tap P/N TAR5

IDMAX 6

1. Last drill in the sequence: diameter 5,4 mm
2. Omit the profile drill stage
3. Use a hexagonal screwdriver P/N 1146, 1046, 0146, 0046, to insert the implant
4. The ID^{MAX} 6 type implants can be set using the one-step, the one and half step or the two-step technique.
5. With poorly mineralized bone the last drill is only inserted up to a third of its length
6. Use the manual thread tap P/N TAR6

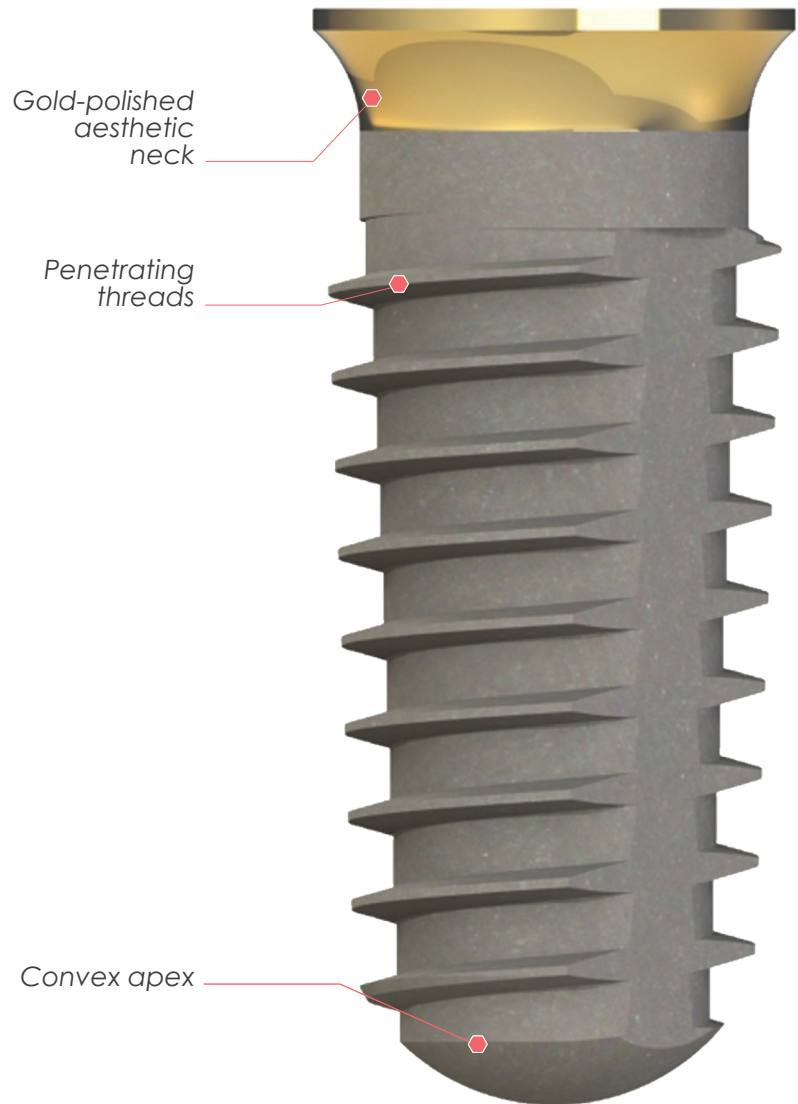

Features of the ID^{MAX} implant :

- Cylindro-tapered-shaped
- Cylindro-tapered-shaped
- Titan alloy two phase Ti6Al4V grade 5
- S.M.A. TiO₂ state of surface
- Hexagonal connection
- Penetrating apex

IMPLANT RANGE



LENGTH Color code*	DIAMETER	P/N
6 mm ●	4,4 mm	IM+0640
6 mm ●	4,9 mm	IM+0650
8 mm ●	4,4 mm	IM+0840
8 mm ●	4,9 mm	IM+0850
8 mm ●	6,6 mm	IM+0860
10 mm ●	4,4 mm	IM+1040
10 mm ●	4,9 mm	IM+1050
10 mm ●	6,6 mm	IM+1060
12 mm ●	4,4 mm	IM+1240
12 mm ●	4,9 mm	IM+1250
12 mm ●	6,6 mm	IM+1260
15 mm ●	4,4 mm	IM+1540
15 mm ●	4,9 mm	IM+1550
15 mm ●	6,6 mm	IM+1560









*On each implant packaging there is a small colored sticker to match with the implant length. The code for each color is related to the one found on the RBS drills for the implants with a hexagonal connection :

- 6 mm length
- 8 mm length
- 10 mm length
- 12 mm length
- 15 mm length





→ SURGICAL SCREWS

HEALING CAP

SCREW	HEIGHT	DIAMETER	IMPLANTS	P/N
	5 mm	5 mm	ID ^{MAX} Ø4,4 mm	413
	3,2 mm	5 mm	ID ^{MAX} Ø4,4 mm	413C
	6,5 mm	5 mm	ID ^{MAX} Ø4,4 mm	413L
	5 mm	5,5 mm	ID ^{MAX} Ø5 mm	513
	3,2 mm	5,5 mm	ID ^{MAX} Ø5 mm	513C
	6,5 mm	5,5 mm	ID ^{MAX} Ø5 mm	513L
	5 mm	7,6 mm	ID ^{MAX} Ø6 mm	613
	3,2 mm	7,6 mm	ID ^{MAX} Ø6 mm	613C

CLOSING CAP

SCREW	IMPLANTS	P/N
	ID ^{MAX} Ø4,4 mm	441
	ID ^{MAX} Ø5 mm	541
	ID ^{MAX} Ø6 mm	641

ID^{MAX} IMPLANTS

Prosthetic guide



SEALED



**Titan abutment
for TEMPORARY TOOTH
Non-rotational**
 Ø4,4 p74
 Ø5 p78
 Ø6,6 p82



**Titan abutment
for TEMPORARY TOOTH
Rotational**
 Ø4,4 p74
 Ø5 p78
 Ø6,6 p82

FOR ONE IMPLANT

FOR MULTIPLE IMPLANTS



**HEXAGONAL
abutments**
 Straight ou Angled
 Ø4,4 p74
 Ø5 p78
 Ø6,6 p82



**HEXAGONAL
abutments**
 Straight ou Angled
 Ø4,4 p74
 Ø5 p78
 Ø6,6 p82

REMOVABLE



**Spherical
attachments**
 Ø4,4 p77
 Ø5 p81
 Ø6,6 p85



**Burnout
spherical
attachments**
 Ø4,4 p77
 Ø5 p81
 Ø6,6 p85



**IDLoc
Attachments**
 Ø4,4 p77
 Ø5 p81
 Ø6,6 p85



SCREWED



TEMPORARY titanium cylinder IDUnit
 Ø4,4 p76
 Ø5 p80
 Ø6,6 p84

FOR ONE IMPLANT

FOR MULTIPLE IMPLANTS



Transgingival Kits
 Non-rotational
 Ø4,4 p75
 Ø5 p79
 Ø6,6 p83



CEREC Tibase
 Ø4,4 p75
 Ø5 p79
 Ø6,6 p83



Burnout cylinders
 Non-rotational
 Ø4,4 p75
 Ø5 p79
 Ø6,6 p83



IDUnit Attachments
 Straight ou Angled
 Ø4,4 p76
 Ø5 p80
 Ø6,6 p84



Transgingival Kits
 Rotational
 Ø4,4 p75
 Ø5 p79
 Ø6,6 p83





Burnout cylinders
 Rotational
 Ø4,4 p75
 Ø5 p79
 Ø6,6 p83

ID^{MAX} Ø4,4 Prosthetic system





Hexagonal

→ PROSTHETIC COMPONENTS

IMPRESSION COPYINGS NON-ROTATIONAL		
	Closed tray technique	905
	Pick-up technique Ø5 mm	906

IMPRESSION COPYINGS ROTATIONAL		
	Straight	7210
	Narrow	7211

IMPLANT ANALOG		
	Implant analog Ø4,4 mm Hexagonal	423

RETAINING SCREWS		
	Retaining screw for tapped screw-retained elements 25 N.cm maximum	0215
	Long head screw for laboratory	0217
	Retaining screw for prosthesis 25 N.cm maximum (short head : Ø2,5mm)	1413
	Retaining screw for prosthesis 25 N.cm maximum	1414





→ THE TEMPORARY PROSTHESIS

TITAN ABUTMENTS FOR A TEMPORARY TOOTH FOR ONE IMPLANT RESTORATION		
	Non-rotational - Ø4,4 mm	APPH44

TITAN ABUTMENTS FOR A TEMPORARY TOOTH FOR MULTIPLE IMPLANTS RESTORATION		
	Rotational - Ø4,4 mm	APPR44

THE SEALED PROSTHESIS

↪ FOR ONE IMPLANT
&
FOR MULTIPLE
IMPLANTS

HEXAGONAL ABUTMENTS			
	DIAMETER	DESCRIPTION	
	Ø4,4 mm	Angled 5°	AM4405G
	Ø4,4 mm	Angled 15°	AM4415G
	Ø4,4 mm	Angled 23°	AM4423G
	Ø4,4 mm	from 0° to 18°	HTU4G



THE SCREWED PROSTHESIS

FOR ONE IMPLANT

TIBASE CEREC		
	Titan base for CEREC Ø4,4 mm	7344

SCANBODY		
	Scanbody CEREC® Bluecam S Type (by 5)	6431295
	Scanbody CEREC® Bluecam L Type (by 5)	6431303
	Scanbody CEREC® Omnicam S Type (by 5)	6431311
	Scanbody CEREC® Omnicam L Type (by 5)	6431329

TRANSGINGIVAL KITS NON-ROTATIONAL		
Ø4,4 MM	TRANSGINGIVAL HEIGHT	
	0,5 mm	6440H
	1,5 mm	6441H
	2,5 mm	6442H

BURNOUT CYLINDER		
	Non-rotational + retaining screw P/N : 1414	H426S

FOR MULTIPLE IMPLANTS

BURNOUT CYLINDER		
	Rotational + retaining screw P/N : 1414	418S

TRANSGINGIVAL KITS ROTATIONAL		
Ø4,4 MM	TRANSGINGIVAL HEIGHT	
	0,5 mm	6440R
	1,5 mm	6441R
	2,5 mm	6442R



ID^{MAX} Ø4,4 Prosthetic system

Hexagonal

THE SCREWED PROSTHESIS





IDUNIT SYSTEM

IDUNIT IMPLANT ANALOG

	Implant analog	333
--	----------------	-----

IDUNIT IMPRESSION COPYINGS

	Closed tray technique	321
	Pick up technique	322
	Pick up technique long	322L

IDUNIT RETAINING SCREWS

	For prosthetic elements 334 and 336. Maximum 15 N. cm	0216
--	--	------

IDUNIT BURNOUT CYLINDER

	IDUnit burnout element + screw P/N : 0216	336S
--	--	------







IDUNIT TEMPORARY TITANIUM CYLINDER

	For IDUnit + screw P/N : 0216	334
--	-------------------------------	-----

IDUNIT HEALING CAP

	For IDUnit	330
--	------------	-----

IDUNIT ABUTMENTS

	ANGULATION	TRANSGINGIVAL HEIGHT	
	Straight	1 mm	U4401
	Straight	2,5 mm	U4402
	Straight	4 mm	U4404
	Straight	6 mm	U4406
	Angled 17°	1 mm	U4121
	Angled 30°	1 mm	U4131









All the dimensions are in mm.



THE REMOVABLE PROSTHESIS

SPHERICAL ATTACHMENTS		
	Transgingival height 1 mm	222441
	Transgingival height 2,5 mm	222442
	Transgingival height 4 mm	222444
	Transgingival height 6 mm	222446

BOXES FOR SPHERICAL ATTACHMENTS		
	O'ring height: 3,5mm Ø external 5mm	0122
	Nitrile retaining ring soft (white)	0120NB
	O'ring retaining ring for O'ring attachment <i>medium</i> (red)	0120SR
	O'ring retaining ring for O'ring attachment <i>strong</i> (black)	0120NN





THE BURNOUT ELEMENTS		
	Spherical attachments	9222
	Paralleling guide for burnout spherical attachments	9223
	Burnout connector bar by 3	0931
	Nylon cap	0025

IDLOC SYSTEM

IDLOC IMPLANT ANALOG		
	Implant analog	433

IDLOC IMPRESSION COPYING		
	Plastic	432

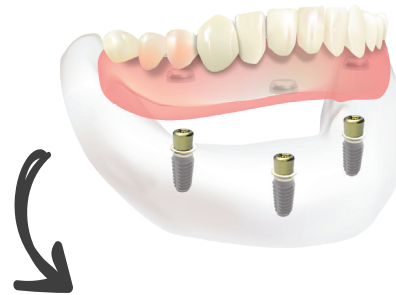

IDLOC ATTACHMENT BOX		
	Female part (Locator) Thickness 2,5mm	LOCFEM

ATTACHMENTS IDLOC		
	Transgingival height 1 mm	L4401
	Transgingival height 2,5 mm	L4402
	Transgingival height 4 mm	L4404
	Transgingival height 6 mm	L4406



Hexagonal

→ PROSTHETIC COMPONENTS





IMPRESSION COPYINGS NON-ROTATIONAL		
	Closed tray technique	905
	Pick-up technique Ø5 mm	906

IMPRESSION COPYINGS ROTATIONAL		
	Straight	7210
	Narrow	7211

→ THE TEMPORARY PROSTHESIS

TITAN ABUTMENTS FOR A TEMPORARY TOOTH FOR ONE IMPLANT RESTORATION		
	Non-rotational - Ø5 mm	APPH50





IMPLANT ANALOG		
	Implant analog Ø4,9 mm Hexagonal	523

RETAINING SCREWS		
	Retaining screw for tapped screw-retained elements 25 N.cm maximum	0215
	Long head screw for laboratory	0217
	Retaining screw for prosthesis 25 N.cm maximum (short head : Ø2,5mm)	1413
	Retaining screw for prosthesis 25 N.cm maximum	1414

TITAN ABUTMENTS FOR A TEMPORARY TOOTH FOR MULTIPLE IMPLANTS RESTORATION		
	Rotational - Ø5 mm	APPR50

THE SEALED PROSTHESIS

→ FOR ONE IMPLANT
&
FOR MULTIPLE
IMPLANTS





HEXAGONAL ABUTMENTS			
	DIAMETER	DESCRIPTION	
	Ø5 mm	Angled 5°	AM5005G
	Ø5 mm	Angled 15°	AM5015G
	Ø5 mm	Angled 23°	AM5023G
	Ø5 mm	From 0° to 18°	HTU5G



THE SCREWED PROSTHESIS

FOR ONE IMPLANT

TIBASE CEREC		
	Titan base for CEREC Ø5 mm	7350



SCANBODY		
	Scanbody CEREC® Bluecam S Type (by 5)	6431295
	Scanbody CEREC® Bluecam L Type (by 5)	6431303
	Scanbody CEREC® Omnicam S Type (by 5)	6431311
	Scanbody CEREC® Omnicam L Type (by 5)	6431329

TRANSGINGIVAL KITS NON-ROTATIONAL		
Ø5 MM	TRANSGINGIVAL HEIGHT	
	0,5 mm	6500H
	1,5 mm	6501H
	2,5 mm	6502H

BURNOUT CYLINDER		
	Non-rotational + retaining screw P/N : 1414	556S

FOR MULTIPLE IMPLANTS

BURNOUT CYLINDER		
	Rotational + retaining screw P/N : 1414	558S

TRANSGINGIVAL KITS ROTATIONAL		
Ø5 MM	TRANSGINGIVAL HEIGHT	
	0,5 mm	6500R
	1,5 mm	6501R
	2,5 mm	6502R



ID^{MAX} Ø5 Prosthetic system

Hexagonal

THE SCREWED PROSTHESIS





IDUNIT SYSTEM

IDUNIT IMPLANT ANALOG

	Implant analog	333
--	----------------	-----

IDUNIT IMPRESSION COPYINGS

	Closed tray technique	321
	Pick up technique	322
	Pick up technique long	322L

IDUNIT RETAINING SCREWS

	For prosthetic elements 334 and 336. Maximum 15 N. cm	0216
--	--	------

IDUNIT BURNOUT CYLINDER

	IDUnit burnout element + screw P/N : 0216	336S
--	--	------







IDUNIT TEMPORARY TITANIUM CYLINDER

	For IDUnit + screw P/N : 0216	334
--	-------------------------------	-----

IDUNIT HEALING CAP

	For IDUnit	330
--	------------	-----

IDUNIT ABUTMENTS

	ANGULATION	TRANSGINGIVAL HEIGHT	
	Straight	1 mm	U5001
	Straight	2,5 mm	U5002
	Straight	4 mm	U5004
	Straight	6 mm	U5006
	Angled 17°	1 mm	U5021
	Angled 30°	1 mm	U5031







All the dimensions are in mm.



THE REMOVABLE PROSTHESIS

SPHERICAL ATTACHMENTS		
	Transgingival height 1 mm	222501
	Transgingival height 2,5 mm	222502
	Transgingival height 4 mm	222504
	Transgingival height 6 mm	222506

BOXES FOR SPHERICAL ATTACHMENTS		
	O'ring height:3,5mm Ø external 5mm	0122
	Nitrile retaining ring <i>soft</i> (white)	0120NB
	O'ring retaining ring for O'ring attachment <i>medium</i> (red)	0120SR
	O'ring retaining ring for O'ring attachment <i>strong</i> (black)	0120NN

THE BURNOUT ELEMENTS		
	Spherical attachments	9222
	Paralleling guide for burnout spherical attachments	9223
	Burnout connector bar by 3	0931
	Nylon cap	0025

IDLOC SYSTEM

IDLOC IMPLANT ANALOG		
	Implant analog	433

IDLOC IMPRESSION COPYING		
	Plastic	432

IDLOC ATTACHMENT BOX		
	Female part (Locator) Thickness 2,5mm	LOCFEM

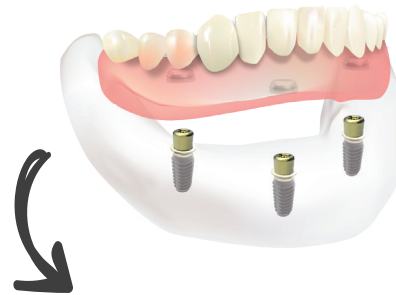

IDLOC ATTACHMENTS		
	Transgingival height 1 mm	L5001
	Transgingival height 2,5 mm	L5002
	Transgingival height 4 mm	L5004
	Transgingival height 6 mm	L5006



ID^{MAX} Ø6,6 Prosthetic system





Hexagonal

→ PROSTHETIC COMPONENTS

IMPRESSION COPYINGS NON-ROTATIONAL		
	Closed tray technique	905
	Pick-up technique Ø5 mm	906

IMPRESSION COPYINGS ROTATIONAL		
	Straight	7210
	Narrow	7211

IMPLANT ANALOG		
	Implant analog Ø4,9 mm Hexagonal	623

RETAINING SCREWS		
	Retaining screw for tapped screw-retained elements 25 N.cm maximum	0215
	Long head screw for laboratory	0217
	Retaining screw for prosthesis 25 N.cm maximum (short head : Ø2,5mm)	1413
	Retaining screw for prosthesis 25 N.cm maximum	1414





→ THE TEMPORARY PROSTHESIS

TITAN ABUTMENTS FOR A TEMPORARY TOOTH FOR ONE IMPLANT RESTORATION		
	Non-rotational - Ø6 mm	APPH60

TITAN ABUTMENTS FOR A TEMPORARY TOOTH FOR MULTIPLE IMPLANTS RESTORATION		
	Rotational - Ø6 mm	APPR60

THE SEALED PROSTHESIS

↪ FOR ONE IMPLANT
&
FOR MULTIPLE
IMPLANTS

HEXAGONAL ABUTMENTS			
	DIAMETER	DESCRIPTION	
	Ø6,6 mm	Angled 5°	AM6005
	Ø6,6 mm	Angled 15°	AM6015
	Ø6,6 mm	Angled 23°	AM6023
	Ø6,6 mm	From 0° to 18°	HTU6

All the dimensions are in mm.



THE SCREWED PROSTHESIS

FOR ONE IMPLANT

TIBASE CEREC		
	Titan base for CEREC Ø5 mm	7350

SCANBODY		
	Scanbody CEREC® Bluecam S Type (by 5)	6431295
	Scanbody CEREC® Bluecam L Type (by 5)	6431303
	Scanbody CEREC® Omnicam S Type (by 5)	6431311
	Scanbody CEREC® Omnicam L Type (by 5)	6431329

TRANSGINGIVAL KITS NON-ROTATIONAL		
Ø5 MM	TRANSGINGIVAL HEIGHT	
	0,5 mm	6500H
	1,5 mm	6501H
	2,5 mm	6502H

BURNOUT CYLINDER		
	Non-rotational + retaining screw P/N : 1414	H626S

FOR MULTIPLE IMPLANTS

BURNOUT CYLINDER		
	Rotational + retaining screw P/N : 1414	618S

TRANSGINGIVAL KITS ROTATIONAL		
Ø5 MM	TRANSGINGIVAL HEIGHT	
	0,5 mm	6500R
	1,5 mm	6501R
	2,5 mm	6502R



ID^{MAX} Ø6,6 Prosthetic system

Hexagonal

THE SCREWED PROSTHESIS



 FOR MULTIPLE IMPLANTS

IDUNIT SYSTEM

IDUNIT IMPLANT ANALOG

	Implant analog	333
--	----------------	-----

IDUNIT IMPRESSION COPYINGS

	Closed tray technique	321
	pick-up	322
	pick-up Long	322L

IDUNIT RETAINING SCREWS

	For prosthetic elements 334 and 336. Maximum 15 N. cm	0216
--	--	------

IDUNIT BURNOUT CYLINDER

	IDUnit burnout element + screw P/N : 0216	336S
--	--	------







IDUNIT TEMPORARY TITANIUM CYLINDER

	For IDUnit + screw P/N : 0216	334
--	-------------------------------	-----

IDUNIT HEALING CAP

	For IDUnit	330
--	------------	-----

IDUNIT ABUTMENTS

	ANGULATION	TRANSGINGIVAL HEIGHT	
	Straight	1 mm	U5001
	Straight	2,5 mm	U5002
	Straight	4 mm	U5004
	Straight	6 mm	U5006
	Angled 17°	1 mm	U5021
	Angled 30°	1 mm	U5031









All the dimensions are in mm.



THE REMOVABLE PROSTHESIS

SPHERICAL ATTACHMENTS		
	Transgingival height 1 mm	222501
	Transgingival height 2,5 mm	222502
	Transgingival height 4 mm	222504
	Transgingival height 6 mm	222506

BOXES FOR SPHERICAL ATTACHMENTS		
	O'ring height:3,5mm Ø external 5mm	0122
	Nitrile retaining ring <i>soft</i> (white)	0120NB
	O'ring retaining ring for O'ring attachment <i>medium</i> (red)	0120SR
	O'ring retaining ring for O'ring attachment <i>strong</i> (black)	0120NN

THE BURNOUT ELEMENTS		
	Spherical attachments	9222
	Paralleling guide for burnout spherical attachments	9223
	Burnout connector bar by 3	0931
	Nylon cap	0025

IDLOC SYSTEM

IDLOC IMPLANT ANALOG		
	Implant analog	433

IDLOC IMPRESSION COPYING		
	Plastic	432

IDLOC ATTACHMENT BOX		
	Female part (Locator) Thickness 2,5mm	LOCFEM

IDLOC ATTACHMENTS		
	Transgingival height 1 mm	L5001
	Transgingival height 2,5 mm	L5002
	Transgingival height 4 mm	L5004
	Transgingival height 6 mm	L5006

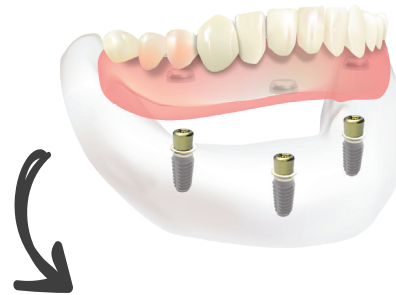



High quality standard
products.

100% made in France
in our manufacturing facility.



The French implant.

Narrow
IMPLANT

ID^{SLIM}
Range

ID^{SLIM} Ø2,8 RANGE

Narrow

PRESENTATION

IDI has developed a narrow implant. The ID^{SLIM} implant with a transgingival esthetic neck is available in 2 heights.

Thanks to the ID^{SLIM}, you may offer to your patient an efficient and cheaper solution, reducing the trauma.

With this mini implant, you do not need a fastidious bone management. It is easy to place, using one drill.

Thanks to the ID^{SLIM}, the prosthetic approach is simplified and quick.

It is particularly adapted for a narrow ridge for the inferior incisors and for the stabilization of an overdenture.

ID^{SLIM} enables the minimally invasive flapless method (thanks to very sharp and deep threads), or the traditional method incl. incision and detachment.

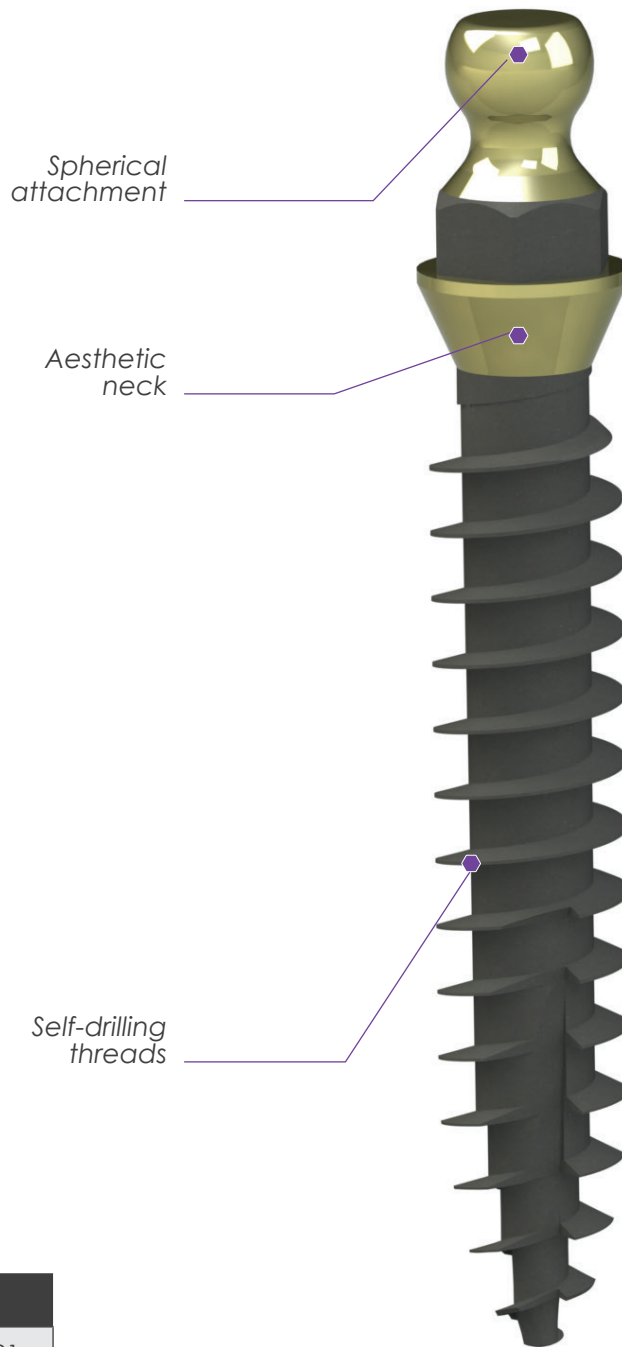

IMPLANT RANGE



LENGTH Color Code*	PLATFORM	HEIGHT	P/N
10 mm ●	Ø3,2 mm	1,5 mm	IDSL1031
10 mm ●	Ø3,2 mm	3 mm	IDSL1033
10 mm ●	Ø3,2 mm	5 mm	IDSL1035
12 mm ●	Ø3,2 mm	1,5 mm	IDSL1231
12 mm ●	Ø3,2 mm	3 mm	IDSL1233
12 mm ●	Ø3,2 mm	5 mm	IDSL1235
15 mm ●	Ø3,2 mm	1,5 mm	IDSL1531
15 mm ●	Ø3,2 mm	3 mm	IDSL1533
15 mm ●	Ø3,2 mm	5 mm	IDSL1535

All the dimensions are in mm.

ID^{SLIM} implant features :

- Cylindro-tapered shaped
- Titanium alloy Ti6Al4V ELI
- SMA + TiO₂ state of surface
- Penetrating apex

Surgical Protocol

THE SIMPLE ID^{SLIM} PROTOCOL

After the clinical examination, use the drill P/N : 1825P (Ø2,5 mm) and stop till the required marking is reached (Bone type II).



Remarks

For a poor mineralized bone (Type III or IV), use the drill P/N : 1820P, Ø2 mm till the depth marking corresponding to the implant length is reached.

For a high mineralized bone (Type I), use the drill P/N : 1825P, Ø2,5 mm to the depth marking corresponding to the implant length. Then use the drill P/N: 1827P, Ø2,7 mm.



Remove the implant from its blister with the screwdriver P/N : 0246 or 0346. Screw the implant at 35 N.cm max.

THE SEALED PROSTHESIS

- Position the impression copying P/N: 821 on the implant ball attachment in the patient mouth, and take the impression.

- Insert the IDSLIM implant analogue P/N: 823 in the impression copying.

or

- Take the impression directly on the implant ball attachment.

- Then position the ball of the ID^{SLIM} implant analog P/N : 823 in the silicone

- Lab step : the technician cast the model and positions the selected ID^{SLIM} abutment to prepare the framework of the prosthetic element.

Then bond the prosthesis with an adequate bonding material on the implant ball attachment.



THE REMOVABLE PROSTHESIS : STABILIZATION OF OVERDENTURE

Use a dam (pierced with a needle) and place it through the implant ball attachment.

- Then snap the O'ring box P/N : 0122 on the attachment and use a dollop of self-curing resin on each box.

- Hollow out the underside surface of the prosthesis with a bur (at the level of the position of the implants).

Position the prosthesis in the patient mouth. The prosthesis is cemented to the O'ring box by the resin.

The removable prosthesis is snapped on the ball attachments of the ID^{SLIM} implants.

Remarks

For a total edentition and in order to stabilize a removable denture, it is recommended to set a minimum of 4 ID^{SLIM} implants at the mandible and 6 ID^{SLIM} implants at the maxillary, as parallel as possible.

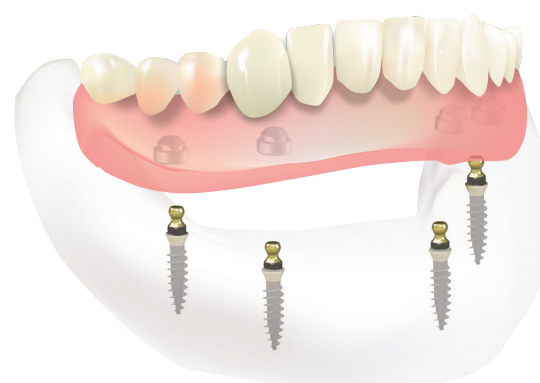

IMPRESSION COPYINGS

	Impression copying ID ^{SLIM}	821
--	---------------------------------------	-----

IMPLANT ANALOG

	Implant analog ID ^{SLIM}	823
---	-----------------------------------	-----

THE SEALED PROSTHESIS





 FOR ONE IMPLANT
 &
 FOR MULTIPLE
 IMPLANTS

HEXAGONAL ABUTMENTS

	DIAMETER	DESCRIPTION	
	Ø3,2 mm	Straight	3000
	Ø3,2 mm	Angled 7°	3007
	Ø3,2 mm	Angled 15°	3015

THE REMOVABLE PROSTHESIS

BOXES FOR SPHERICAL ATTACHMENTS

	O'ring height:3,5mm Ø external 5mm	0122
	Nitrile retaining ring <i>soft</i> (white)	0120NB
	O'ring retaining ring for O'ring attachment <i>medium</i> (red)	0120SR
	O'ring retaining ring for O'ring attachment <i>strong</i> (black)	0120NN

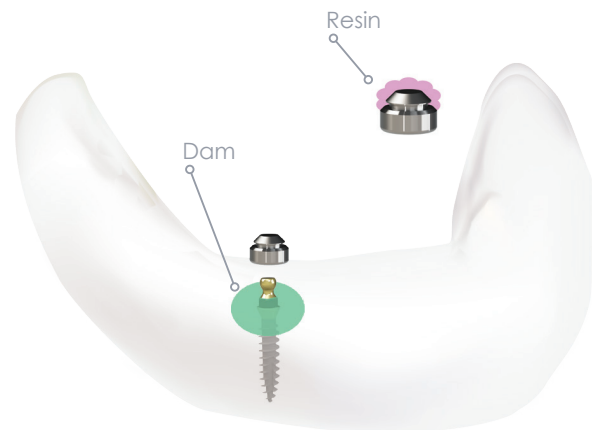



SURGICAL
SETS
&
DRILLS

The **TURBOdrill**®

ID ^{CAM/BIO} DRILL 4 BLADES CONICAL WITH DEPTH STOP TURBOdrill		
LENGTH Color code*	DIAMETER	P/N
8 mm ●	3,6 mm	0835TD
8 mm ●	4,2 mm	0842TD
8 mm ●	5,2 mm	0852TD
10 mm ●	3,6 mm	1035TD
10 mm ●	4,2 mm	1042TD
10 mm ●	5,2 mm	1052TD
12 mm ●	3,6 mm	1235TD
12 mm ●	4,2 mm	1242TD
12 mm ●	5,2 mm	1252TD
15 mm ●	3,6 mm	1535TD
15 mm ●	4,2 mm	1542TD
15 mm ●	5,2 mm	1552TD



PRESENTATION

The **TURBOdrill**® is a cylindro-tapered drill with 4 serrated blades.

It has a hollowed out stopper with blades acting as a turbine and leading the irrigation liquid along the blades till the bone socket.

This intense irrigation phenomenon optimizes the cooling of the drill and thus of the operating site.

The **TURBOdrill**® may be used up to 1 800 rpm with irrigation without bone heating up.

The fixed stopper enables a safe drilling even with high speed.

ID ^{ALL} DRILL 4 BLADES CYLINDRO-TAPERED WITH DEPTH STOP TURBOdrill		
LENGTH Color code*	DIAMETER	P/N
8 mm ●	3,8 mm	X0838TD
8 mm ●	4,2 mm	X0842TD
8 mm ●	5,2 mm	X0852TD
10 mm ●	3,8 mm	X1038TD
10 mm ●	4,2 mm	X1042TD
10 mm ●	5,2 mm	X1052TD
12 mm ●	3,8 mm	X1238TD
12 mm ●	4,2 mm	X1242TD
12 mm ●	5,2 mm	X1252TD
15 mm ●	3,8 mm	X1538TD
15 mm ●	4,2 mm	X1542TD
15 mm ●	5,2 mm	X1552TD
18 mm ●	3,8 mm	X1838TD
18 mm ●	4,2 mm	X1842TD
18 mm ●	5,2 mm	X1852TD

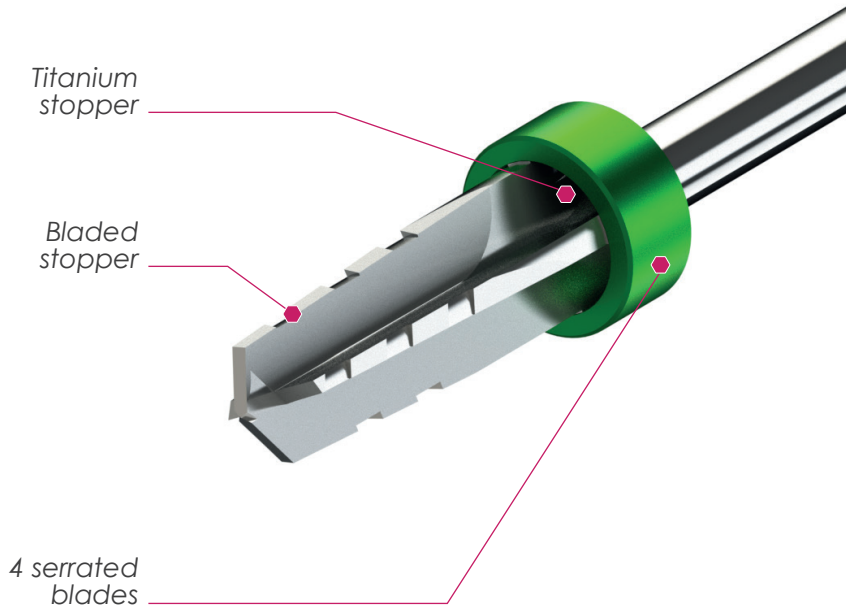

There are two sizes:

- **TURBOdrill**® for the ID^{CAM} and ID^{BIO} implants.
- **TURBOdrill**® for the ID^{ALL} implants.

Several studies show that the irrigation, the pressure exerted by the practitioner when drilling, the drilling duration and more generally the bone temperature rise have an impact on the osseointegration of the implant inserted. The **TURBOdrill**® plays on all these factors in order to optimize the implant success.

All the dimensions are in mm.

ID^{CAM} TD Surgical set



CONTENTS :

12 TURBOdrill®

4 RBS Ø2mm drill

1 pointing drill (L15 Ø1,8 with depth marks P/N : 1518PT)

ABUNDANT IRRIGATION DOWN INTO THE SOCKET

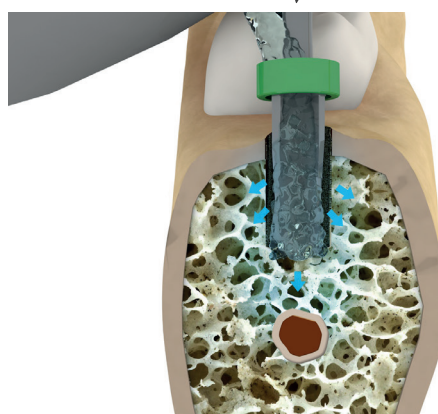

INSTRUMENTS	
Ratchet	415
Paralleling guide ø2 mm / Ø2,35 mm	410
Depth tester (18mm)	408
Instrument extension	406
Instruments with dental shank	
Square-tipped 1x1mm, short 22mm, for prosthetic screw	1014
Hex-tipped 2,5 x 2,5mm, short 22mm, for implant setting	1046
Square-tipped 1x1mm, long 30mm, for prosthetic screw	1114
Hex-tipped 2,5 x 2,5mm, long 30mm, for implant setting	1146
Screwdrivers	
Square-tipped 1x1mm, manual and for ratchet, short 22mm, for prosthetic elements	0014
Hex-tipped 2,5 x 2,5mm, manual and for ratchet, short 22mm, for implant setting	0046
Abutment remover (M2), long 30mm	0048
Square-tipped 1x1mm, manual and for ratchet, long 30mm, for prosthetic elements	0114
Hex-tipped 2,5 x 2,5mm, manual and for ratchet, long 30mm, for implant setting	0146

*On each implant packaging there is a small colored sticker to match with the implant length. The code for each color is related to the one found on the TURBOdrill® drills :

- 8 mm length
- 10 mm length
- 12 mm length
- 15 mm length
- 18 mm length

ID^{ALL} TD Surgical set

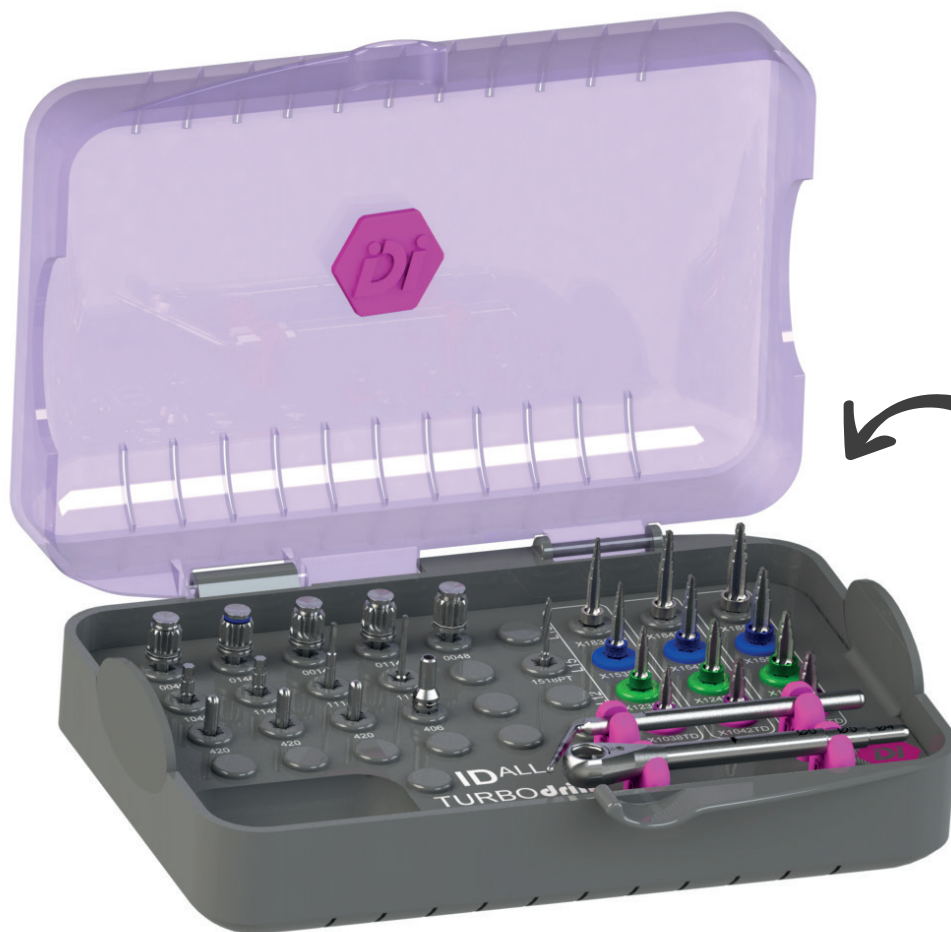

CONTENTS :

12 ID^{ALL} TURBOdrill® drills
(the set do not content the 8mm length drills)

1 pointing drill
(L15 Ø1,8
with depth marks
P/N : 1518PT)

INSTRUMENTS

Ratchet	415
Paralleling guide ø2 mm / Ø2,35 mm	420
Depth tester	412
Instrument extension	406
Instruments with dental shank	
Square-tipped 1x1mm, short 22mm, for prosthetic screw	1014
Hex-tipped 2,5 x 2,5mm, short 22mm, for implant setting	1046
Square-tipped 1x1mm, long 30mm, for prosthetic screw	1114
Hex-tipped 2,5 x 2,5mm, long 30mm, for implant setting	1146
Screwdrivers	
Square-tipped 1x1mm, manual and for ratchet, short 22mm, for prosthetic elements	0014
Hex-tipped 2,5 x 2,5mm, manual and for ratchet, short 22mm, for implant setting	0046
Abutment remover mixt (M2), long 30mm	0048
Square-tipped 1x1mm, manual and for ratchet, long 30mm, for prosthetic elements	0114
Hex-tipped 2,5 x 2,5mm, manual and for ratchet, long 30mm, for implant setting	0146

OPTIMIZED IRRIGATION

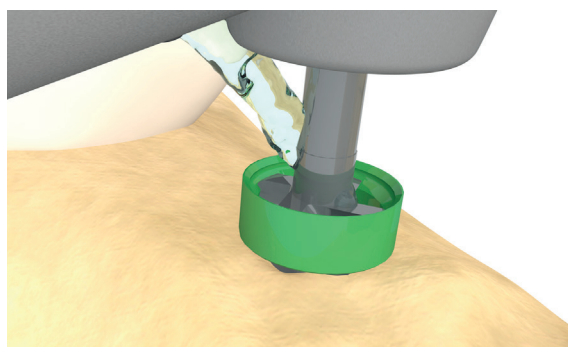

*On each implant packaging there is a small colored sticker to match with the implant length. The code for each color is related to the one found on the ID^{ALL} TURBOdrill® drills :

- 10 mm length
- 12 mm length
- 15 mm length
- 18 mm length

ID^{ALL} Surgical set



CONTENTS :

12 ID^{ALL} drills
(the set doesn't content the 8mm length drills)

1 pointing drill
(L15 Ø1,8 with depth marks
P/N : 1518PT)

*On each implant packaging there is a small colored sticker to match with the implant length. The code for each color is related to the one found on the ID^{ALL} drills :

- 8 mm length
- 10 mm length
- 12 mm length
- 15 mm length
- 18 mm length

INSTRUMENTS	
Ratchet	415
Paralleling guide ø2 mm / Ø2,35 mm	420
Depth tester	412
Instrument extension	406
Instruments with dental shank	
Square-tipped 1x1mm, short 22mm, for prosthetic screw	1014
Hex-tipped 2,5 x 2,5mm, short 22mm, for implant setting	1046
Square-tipped 1x1mm, long 30mm, for prosthetic screw	1114
Hex-tipped 2,5 x 2,5mm, long 30mm, for implant setting	1146
Screwdrivers	
Square-tipped 1x1mm, manual and for ratchet, short 22mm, for prosthetic elements	0014
Hex-tipped 2,5 x 2,5mm, manual and for ratchet, short 22mm, for implant setting	0046
Abutment remover mixt (M2), long 30mm	0048
Square-tipped 1x1mm, manual and for ratchet, long 30mm, for prosthetic elements	0114
Hex-tipped 2,5 x 2,5mm, manual and for ratchet, long 30mm, for implant setting	0146



ID ^{ALL} DRILL – 4 CYLINDRO-TAPERED BLADES		
LENGTH Color code*	DIAMETER	P/N
8 mm ●	3,8 mm	X0838
8 mm ●	4,2 mm	X0842
8 mm ●	5,2 mm	X0852
10 mm ●	3,8 mm	X1038
10 mm ●	4,2 mm	X1042
10 mm ●	5,2 mm	X1052
12 mm ●	3,8 mm	X1238
12 mm ●	4,2 mm	X1242
12 mm ●	5,2 mm	X1252
15 mm ●	3,8 mm	X1538
15 mm ●	4,2 mm	X1542
15 mm ●	5,2 mm	X1552
18 mm ●	3,8 mm	X1838
18 mm ●	4,2 mm	X1842
18 mm ●	5,2 mm	X1852

The RBS C drill

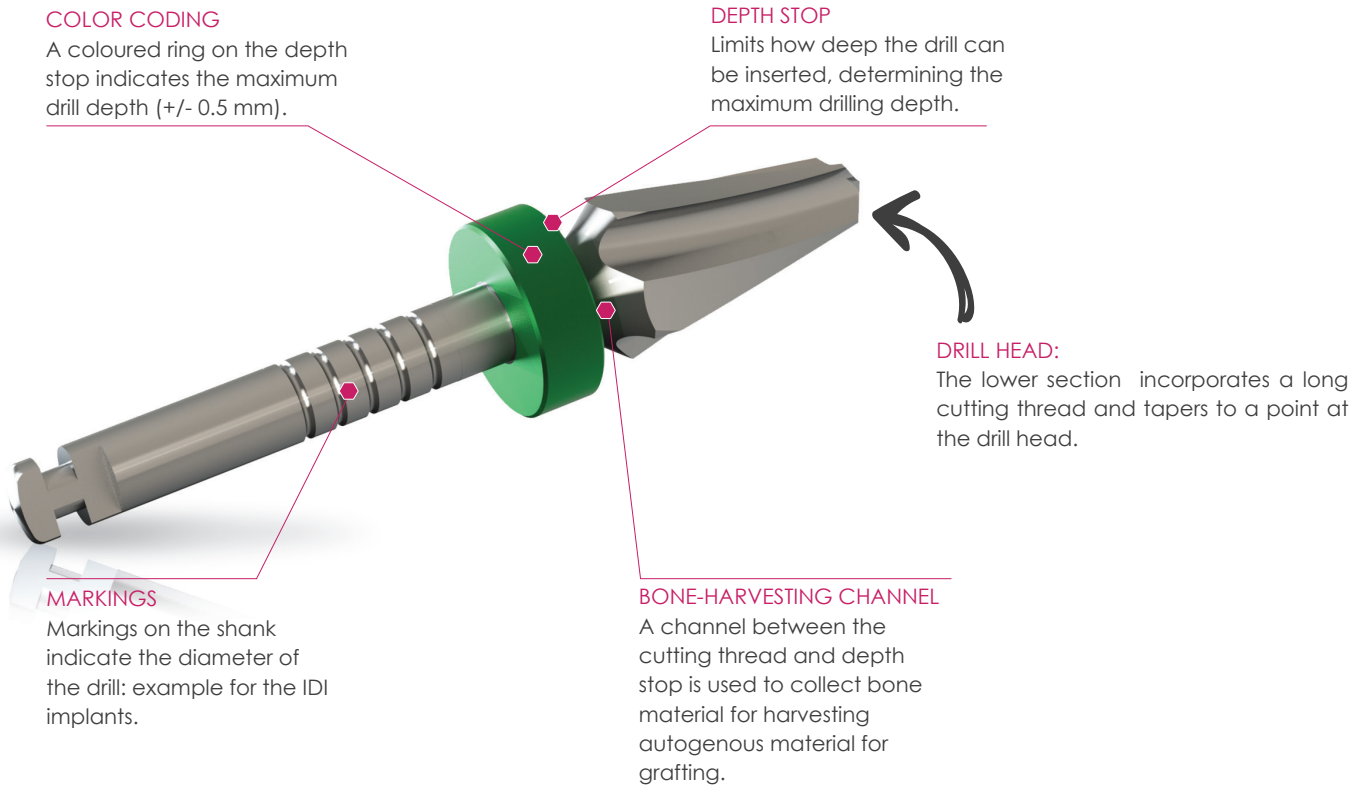

THE RBS C DRILL		
LENGTH Color code*	DIAMETER	P/N
8 mm ●	3,5 mm	083522
8 mm ●	4,2 mm	084227
8 mm ●	5,2 mm	085230
10 mm ●	3,5 mm	103522
10 mm ●	4,2 mm	104223
10 mm ●	5,2 mm	105225
12 mm ●	3,5 mm	123522
12 mm ●	4,2 mm	124223
12 mm ●	5,2 mm	125225
15 mm ●	3,5 mm	153522
15 mm ●	4,2 mm	154223
15 mm ●	5,2 mm	155225

PRESENTATION

RBS drills for harvesting bone were developed and tested in cooperation with dental hospitals. They are precisely tailored to user requirements and meet the highest standards of implantology.

*On each implant packaging there is a small colored sticker to match with the implant length. The code for each color is related to the one found on the RBS C drills :

- 8 mm length
- 10 mm length
- 12 mm length
- 15 mm length

ID^{CAM}/BIO Surgical set



CONTENTS :

12 **RBS C** drills

4 RBS Ø2mm drills

1 pointing drill
(L15 Ø1,8 with depth marks
P/N : 1518PT)

INSTRUMENTS

Ratchet	415
Paralleling guide ø2 mm / Ø2,35 mm	410
Depth tester (18mm)	408
Instrument extension	406
Instruments with dental shank	
Square-tipped 1x1mm, short 22mm, for prosthetic screw	1014
Hex-tipped 2,5 x 2,5mm, short 22mm, for implant setting	1046
Square-tipped 1x1mm, long 30mm, for prosthetic screw	1114
Hex-tipped 2,5 x 2,5mm, long 30mm, for implant setting	1146
Screwdrivers	
Square-tipped 1x1mm, manual and for ratchet, short 22mm, for prosthetic elements	0014
Hex-tipped 2,5 x 2,5mm, manual and for ratchet, short 22mm, for implant setting	0046
Abutment remover mixt (M2), long 30mm	0048
Square-tipped 1x1mm, manual and for ratchet, long 30mm, for prosthetic elements	0114
Hex-tipped 2,5 x 2,5mm, manual and for ratchet, long 30mm, for implant setting	0146



For more information about our drills and surgical sets, contact our customer service by phone:

+33 (0)1 48 70 70 48

RBS 3 Surgical set

PRESENTATION

The RBS3 surgical set provides for perio-implantologists who want to harvest bone during a surgery for an autogenous graft.

This set contains 24 drills and additional instruments which are required to place ID^{MAX} implants and all cylindrical implants.

Drill available in lengths 6, Ø2, Ø3, Ø3.5, and Ø4 mm, on demand.

N.B. : the Ø1,5 mm and Ø2 mm drills do not have a bone-harvesting channel.



INSTRUMENTS	
Ratchet + central part	414
Paralleling guide ø1,5 mm / Ø2,35 mm	409
Instrument extension	406
Instruments with dental shank	
Universal profile drill	401
Square-tipped 1,4x1,4 mm, short, for prosthetic screw	403
Hex-tipped 2,5 x 2,5mm, long 30mm, for implant setting	1146
Screwdrivers	
Square-tipped 1x1mm, manual and for ratchet, short 22mm, for prosthetic elements	0014
Hex-tipped 2,5 x 2,5mm, manual and for ratchet, short 22mm, for implant setting	0046
Square-tipped screwdriver, 1,4 x 1,4mm, for prosthesis, long 24mm	403ML

RBS DRILL		
LENGTH Color code*	DIAMETER	P/N
8 mm ●	1,5 mm	815
8 mm ●	2,0 mm	820
8 mm ●	2,5 mm	R825
8 mm ●	3,0 mm	R830
8 mm ●	3,5 mm	R835
8 mm ●	4 mm	R840
10 mm ●	1,5 mm	1015
10 mm ●	2,0 mm	1020
10 mm ●	2,5 mm	R1025
10 mm ●	3,0 mm	R1030
10 mm ●	3,5 mm	R1035
10 mm ●	4 mm	R1040
12 mm ●	1,5 mm	1215
12 mm ●	2,0 mm	1220
12 mm ●	2,5 mm	R1225
12 mm ●	3,0 mm	R1230
12 mm ●	3,5 mm	R1235
12 mm ●	4 mm	R1240
15 mm ●	1,5 mm	1515
15 mm ●	2,0 mm	1520
15 mm ●	2,5 mm	R1525
15 mm ●	3,0 mm	R1530
15 mm ●	3,5 mm	R1535
15 mm ●	4 mm	R1540

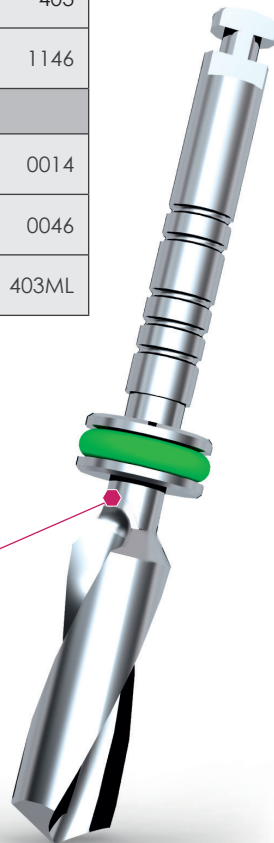

BONE-HARVESTING CHANNEL

A channel between the cutting thread and depth stop is used to collect bone material for harvesting autogenous material for grafting.

All the dimensions are in mm.

ID^{SLIM} Surgical set



DRILLS WITHOUT DEPTH STOP		
LENGTH	DIAMETER	P/N
18 mm	2 mm	1820P
18 mm	2,5 mm	1825P
18 mm	2,8 mm	1827P

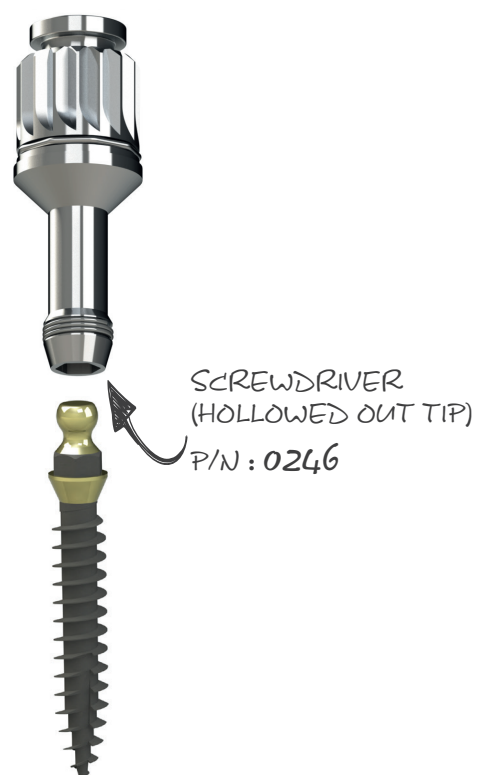

INSTRUMENTS	
Ratchet	415
Paralleling guide \varnothing 2 mm / \varnothing 2,35 mm	410
Instrument extension	406
Instruments with dental shank	
Hexagon socket 2,5mm with dental shank to screw the ID ^{SLIM} implant, short	1246
Screwdrivers	
Hexagon socket, manual and for ratchet, to screw the ID ^{SLIM} implant, short 22mm	0246
Hexagon socket, manual and for ratchet, to screw the ID ^{SLIM} implant, long 30mm	0346

Request for a quotation directly on our website : www.idi-dental.com



The Osteosinus

The safe sinus floor elevation

PRESENTATION

Consistent use of a depth stop over many years when harvesting bone surgically and the experience this provided enabled development of this technique. The technique has proved itself in a wide range of applications for more than fifteen years thanks to the rbs depth stop drills from **IMPLANTS DIFFUSION INTERNATIONAL**.

Osteotomes, trephines and drills included in the Osteosinus system have also benefited from this technology.

The Osteosinus concept facilitates sinus floor elevation and ensures that it is stress-free.

Clinical studies have indicated that an intact sinus membrane is essential for successful grafting.

A sinus bone graft can either be harvested laterally (sinus lift) or crestally.

In many cases crestal sinus floor elevation completed with the Osteosinus is a practical alternative to a sinus lift.

Osteosinus
(osteotome holder)
P/N : OST 1

Osteosinus monobloc
P/N : OSTM

surgical stand
P/N : PLS

Base plate
P/N : BIC1



OSTEOSINUS

It is used for attaching a straight or angled osteotome depending on the operating site. After assembling the osteotome, use the slide mallet to compact the bone. Removable slide mallet.

Can be dismantled.



TREPANOSINUS x6

(Trephines with a colour-coded depth stop)
Use the trephine at 70 rpm without water cooling.

LENGTH	Ø 3 MM
③	TL 33
④	TL 43
⑤	TL 53
⑥	TL 63
⑦	TL 73
⑧	TL 83



FORSINUS x6

(Drills with a bone-harvesting channel and colour-coded depth stop).
Use the Forsinus at 150 rpm without water cooling and 650 rpm with irrigation.

LENGTH	Ø 3 MM
③	FL 33
④	FL 43
⑤	FL 53
⑥	FL 63
⑦	FL 73
⑧	FL 83



RECTISINUS x6

Straight osteotomes with a colour-coded depth stop. Insert the Rectisinus into the osteotome, position the guide in the operating site and compact the bone using the slide mallet.

LENGTH	Ø 3 MM
③	RL 33
④	RL 43
⑤	RL 53
⑥	RL 63
⑦	RL 73
⑧	RL 83



ANGULOSINUS x6

(angled osteotomes with a colour-coded depth stop)
Insert the Angulosinus into the osteotome, position the guide in the operating site and compact the bone using the slide mallet.

LENGTH	Ø 3 MM
③	AL 33
④	AL 43
⑤	AL 53
⑥	AL 63
⑦	AL 73
⑧	AL 83



DISKOSINUS

Small bladed wheel, Ø 3 mm (red ring)
P/N : D3

The wheel is used after the Forsinus drill with the same diameter. Using a circular movement the bladed wheel enlarges the bone base below the sinus and provides it which increased resilience when using the osteotome.



Important : the instruments Ø3mm are used for standard implants (Ø from 3, 5 to 4,4mm).

The Diskosinus



TECHNIQUE BY USING FORSINUS

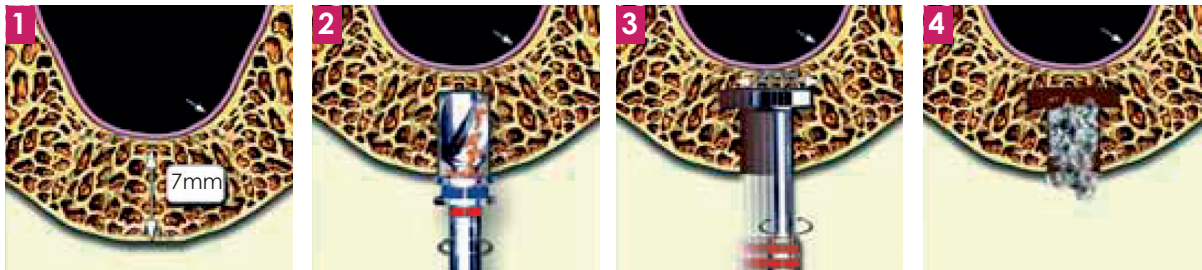

1 Select a suitable section on the X-ray of the implant site and measure the bone availability (here: 7 mm).

2 Use the 6 mm long forsinus® drill (red ring on top) with a bone availability of 7 mm.

3 Use the diskosinus bladed wheel, rotating it slowly with a circular movement, to enlarge the bone base below the sinus and provide it which increased resilience.

4 Fill the cavity with filler material.

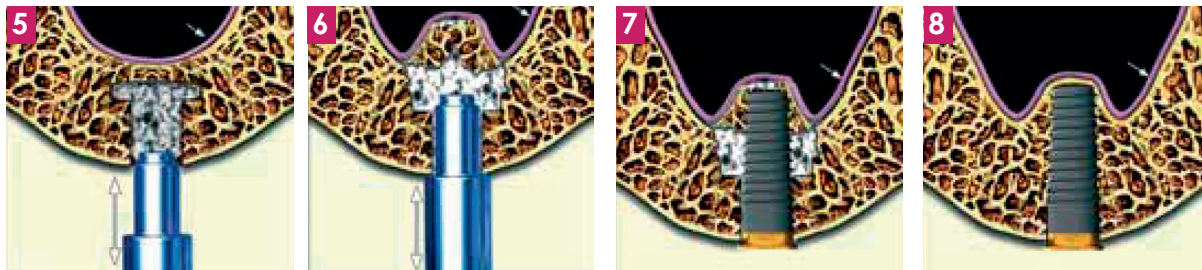

5 Attach a 7 mm long osteotome (red ring on top) to the Osteosinus and use the instruments to compact the bone. Sometimes in front of a very resistant bone, it is necessary to start compacting with a surgical hammer.

6 Repeat the procedure until 1.5 to 2 cubic centimeters of filler material has been inserted. This gently elevates the sinus membrane without tearing it.

7 Then place the implant.

8 Allow a healing period of approx 8 months during which osseointegration is completed.

TECHNIQUE BY USING THE TREPANOSINUS

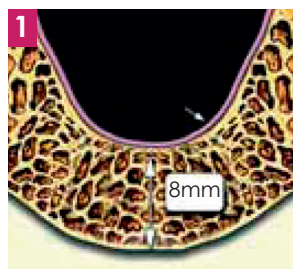

1 Select a suitable section on the X-ray of the implant site and measure the bone availability (here: 8 mm).

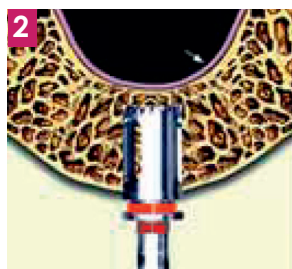

2 Use a 7 mm long trephine Trepanosinus® (red ring on top) with a bone availability of 8 mm.

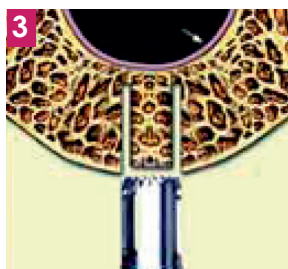

3 Remove the trephine.



4 Depending on the composition of the operating site, select a straight or angled 8 mm long Osteosinus (yellow ring on top), attach it and use it to compact the bone cylinder. Sometimes because of a very resistant bone, it is necessary to start compacting with a surgical hammer.

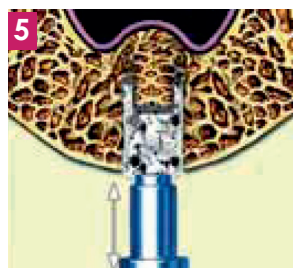

5 Fill the cavity with the filler material.

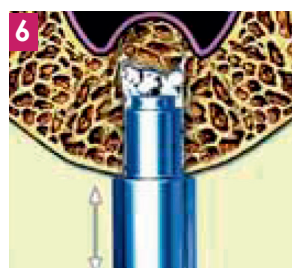

6 Continue compacting the bone. The filler material gradually elevates the sinus membrane.

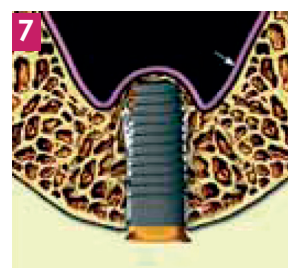

7 Place the implant after compacting approx. 2 cubic centimeters of the filler material.

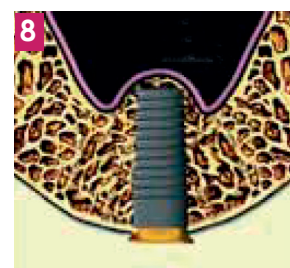

8 Allow a healing period of approx. 8 months during which osseointegration is completed.

NOTE:

we recommend checking osseointegration with a scanner before loading the implant.

See the full information about the **Osteosinus**, and a sinus floor elevation by crestal approach **surgery video with the Osteosinus technique** on :

www.idi-dental.com/fr/produit/osteosinus



The ID'BOX

Supporting your surgery

ID'PARALLELISOR

FOR MORE PRECISION, THIS ID'BOX GUIDES YOUR IMPLANT SETTING.

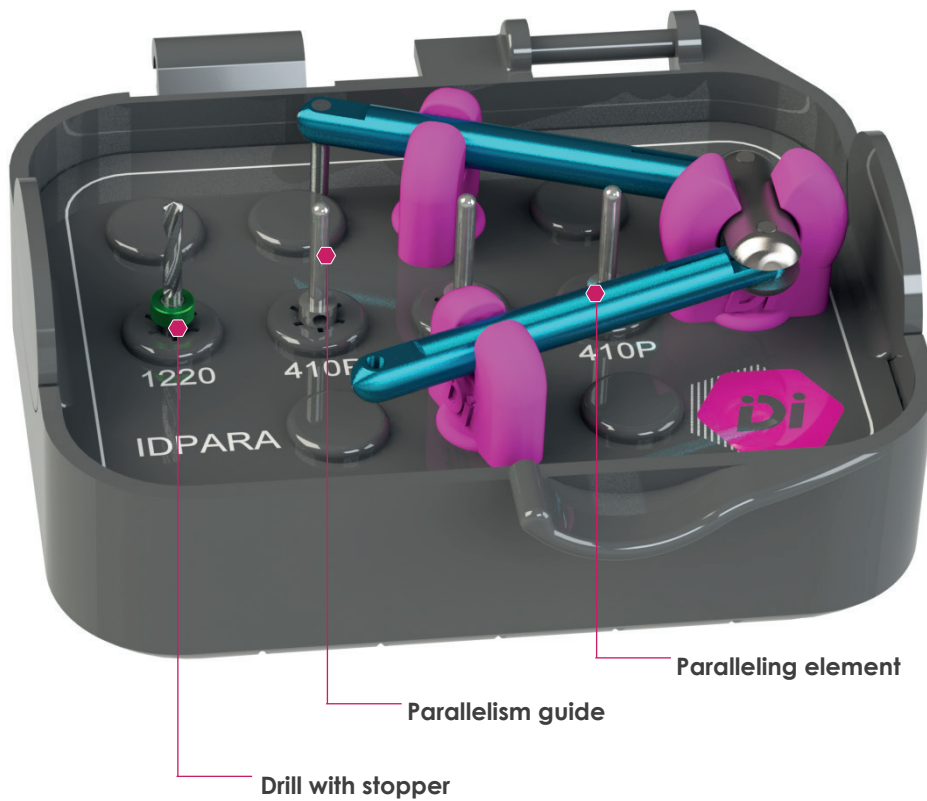

PRESENTATION

This box is indicated for the placement of the implants in a paralleling way to maximize the life of the prosthetic attachments.

CONTENTS :

- 1 drill with stopper
- 3 parallelism guides
- 1 paralleling element (articulated instrument)

ID-PARALLELISOR PROTOCOL

STEP 1

Drill perpendicular to the basal bone with the drill (green stopper).



STEP 2

Insert the stem of the paralleling element into the freshly drilled socket. Shift the parallelisor axis and drill through the hole located in the parallelisor arm where the 2nd implant must emerge.

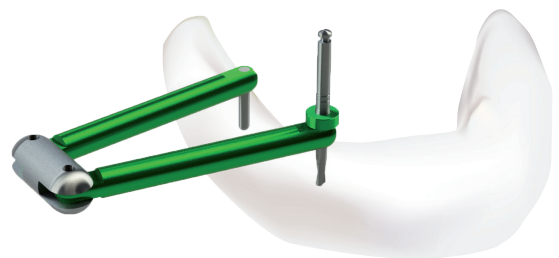

ID'SPASSOR

THE SOLUTION TO MANAGE THE VOLUME OF THE PROSTHETIC TOOTH.

CONTENTS :

6 pointing drills.
Drilling part length :
7 mm and Ø2 mm.

6 spacing guides.
From Ø4,5 mm to Ø12 mm.

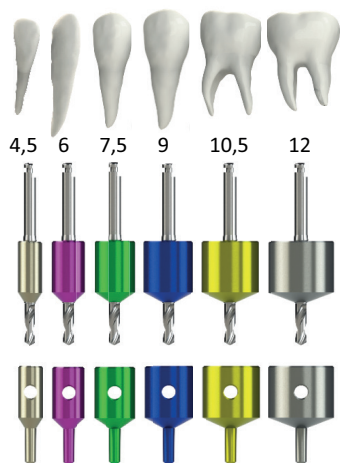

ID-SPASSOR PROTOCOL

The drilling guides are intended to create a predrilling position for an implant setting, perfectly positioned in the middle of the future prosthetic tooth.

The spacing guide materializes the perfect volume of the prosthetic tooth.

STEP 1

Use the pointing drill adapted to the mesio distal space of the tooth and stick it to the side of the adjacent tooth, then proceed to drilling.



STEP 2

Remove the drill and replace it by the spacing guide of the same color.



1. Drill with the pointing drill

2. Remove the pointing drill

3. Insert the spacing guide

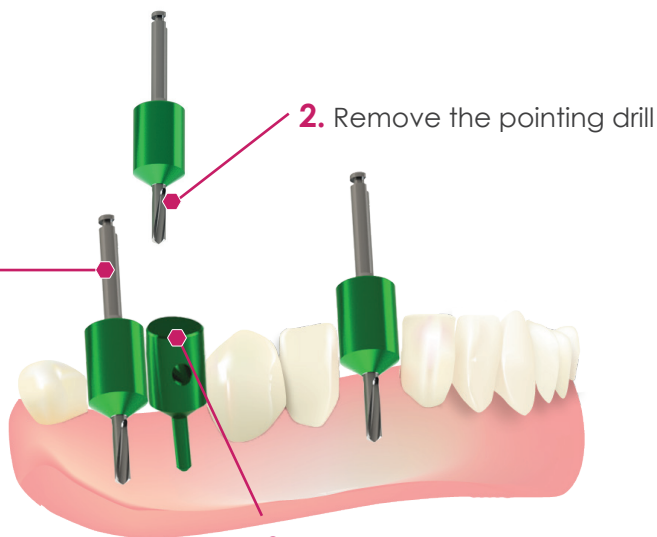

Accessories & Instruments

ID'PRO

THIS BOX GATHERS ALL THE ESSENTIAL TOOLS FOR THE IDI PROSTHESIS.



SURGICAL INSTRUMENTS

TREPHINES



LENGTH	Ø 3 MM	Ø 4 MM
③	TL 33	TL 34
④	TL 43	TL 44
⑤	TL 53	TL 54
⑥	TL 63	TL 64
⑦	TL 73	TL 74
⑧	TL 83	TL 84

THREAD TAPS



DIAMETER	P/N
4 mm	TAR 4
5 mm	TAR 5
6 mm	TAR 6



























Manual thread tap, hardened stainless steel M2 TAR M2

Very sharp trephines in surgical stainless for bone explantation : equipped with depth stops and lateral windows for an easy clearing of the recovered bone.

All the dimensions are in mm.

Accessories & Instruments

RATCHETS		
	Ratchet + central part	414
	Ratchet	415
	Central part	416
INSTRUMENTS WITH DENTAL SHANK		
	Instruments with dental shank, square-tipped instrument (short)	1014
	Instruments with dental shank, hex-tipped instrument (short)	1046
	Instruments with dental shank, square-tipped instrument (long)	1114
	Instruments with dental shank, hex-tipped instrument (long)	1146
	Hexagon socket, manual and for ratchet, to screw the ID ^{SLIM} implant, short 22mm	1246
	Square tipped 1,4 x 1,4 mm short for retaining screw	403
	Instrument extension	406

SCREWDRIVERS		
	Square tipped 1 x 1mm, manual and for ratchet, for prosthesis, short 16mm	0004
	Screwdriver for relating instruments (short model)	0014
	Short hex-tipped screwdriver	0046
	Abutment remover for tapered implants, mixt (M2), Ø8mm, length 30mm	0048
	Square-tipped 1x1mm, manual and for ratchet, for prosthesis, length 30mm	0114
	Hex-tipped screwdriver long	0146
	Abutment remover for tapered implants, mixt (M2), Ø8mm, length 34mm	0148
	Manual screwdriver to screw the implant	0846
	Screwdriver (hollowed out tip) for ID ^{SLIM} implant, short (22 mm), manually or with the ratchet	0246
	Screwdriver (hollowed out tip) for ID ^{SLIM} implant, long (30 mm), manually or with the ratchet	0346
	Square-tipped screwdriver, long, width 2mm, for closing cap and healing caps	403ML
	Square-tipped screwdriver, short, width 2mm, for closing cap and healing caps	403M
	Square-tipped screwdriver, long, width 1,2mm, for impression copyings	405ML
	Square-tipped screwdriver, short, width 1,2mm, for impression copyings	405M

Important considerations about IDI System

TIGHTENING TORQUES

PRODUCTS	VALUES (Ncm°)	COMMENTS
IMPLANTS	≤75	Use the ratchet
CLOSING CAP	5 to 10	Use the manual screwdriver*
HEALING CAP	5 to 10	
IDUNIT : ABUTMENT	25	
IDUNIT : RETAINING SCREW	15	
RETAINING SCREW	25	
MANUAL SCREWDRIVER	5 to 25	
SCREWDRIVER WITH DENTAL SHANK	25	Use the contra angle or the torque wrench*

*Distortion of the screwdriver at 45 N.cm to preserve the implant and its prosthetic component.

CLEANING INSTRUCTIONS FOR THE SURGICAL SETS

1. Use powder-free gloves exclusively.
 2. Soak the surgical set with the instruments in a decontamination bath (Alkazyme powder 0,5% type) during 15 minutes.
 3. Rinse with clear water in an ultrasonic tray during 10 minutes.
 4. Remove all the instruments from the set.
 5. Clean each rotative instrument with a soft brush in order to remove any bone fragment.
 6. Rinse with clear water in an ultrasonic tray during 10 minutes.
 7. Clean the instruments and the base plate separately in an ultrasonic tray during **15 minutes with a powdered decontamination product** (Alkazyme powder 0,5% type).
 8. Change gloves.
 9. **Put the instruments and the base plate in an ultrasonic bath during 5 minutes, in clear water.**
- Repeat the process 5 times 5 minutes, renewing the water
10. Dry all surgical instruments.
 11. Put the instruments back in the base plate, **using non-powdered gloves.**

STERILIZATION INSTRUCTIONS FOR THE SURGICAL SETS

12. Place the closed surgical set in a sterilization bag
13. Sterilize by autoclaving at 134°C **during 18 minutes** according to the instructions of European Pharmacopoeia (8th Edition)

 **NB1 : Failure to comply with these recommendations may lead to the surgery failure and the medical device loss.**

 **NB2 : It is recommended to clean the implantology surgical material manually.**

SURGICAL SET Protocol

DRILLING RECOMMENDATIONS FOR THE ID^{CAM/BIO}, RBS3 SURGICAL SET



MAXILLA

1. First drilling Ø2 mm with irrigation 650 rpm.
2. Second and third drilling without irrigation at 150 rpm. With irrigation at 350 rpm (Torque 70N.cm)
3. Rinse abundantly the socket with an antibiotic (tobramycin type), diluted with physiological serum before implant setting.



MANDIBLE

1. First drilling Ø2 mm with irrigation 650 rpm.
2. Second and third drilling with irrigation at 650 rpm.
3. Rinse abundantly the socket with an antibiotic (tobramycin type), diluted with physiological serum before implant setting.

DRILLING RECOMMENDATIONS FOR THE ID^{ALL} SURGICAL SET



MAXILLA

1. First drilling Ø2 mm with irrigation 650 rpm.
2. Second drilling Ø3,8 mm at 1500 rpm under full irrigation to the required length. The 4-bladed drills shall be used without up and down movements.



MANDIBLE

1. First drilling Ø2 mm with irrigation 650 rpm.
2. Second drilling Ø3,8 mm at 1500 rpm under full irrigation.
3. Third drilling Ø4,2 mm at 1500 rpm under full irrigation to the total length.

For poorly mineralized bone (Type IV), the final drill shall be narrower than the implant diameter.

→ IMPLANT PLACEMENT

1. Insert the implant 1 mm subcrestally (for any IDI implant range)
2. Screw the closing cap and the healing cap manually at 5 N.cm



EXPERT ADVICE :

Before the implant insertion : Soak the implant, the closing cap and the healing cap in tobramycine (75mg) diluted in 20 cl of physiological serum.

LIFE CYCLE :

The drills shall be replaced after 20 uses or as soon as their cutting capacity decreases. Used drills must be decontaminated or handled as waste of infectious risk care activities.

SURGICAL SET

Protocol

DRILLING RECOMMENDATIONS WITH THE TURBOdrill® set

PROTOCOL - DRILLING WITHOUT BONE RECOVERING

Example : For a Ø4,2mm implant



MAXILLA

1. Use the Ø2mm pilot drill. Drill at 650 rpm with irrigation.
2. Then, use the Ø3,5mm drill, till 1500 rpm with intense irrigation.



MANDIBLE

1. First drilling : Use the Ø2mm pilot drill. Drill at 650 rpm with irrigation.
2. Second drilling : Use the Ø3,5mm drill, till 1500 rpm with intense irrigation.
3. Third drilling : Use the Ø4,2mm drill at 1500 rpm with intense irrigation :
 - If the bone is poorly mineralized, drill to 2/3 of the drill length only.
 - If the bone is very mineralized, insert the drill entirely.
4. **After the last drilling, rinse the socket abundantly with tobramycin, diluted with physiological serum before implant placement.**

→ IMPLANT PLACEMENT

1. Screw the implant 1 mm subcrestally (for any implant line).
2. Screw the closing cap or the healing cap at 5 N.cm manually.



OUR EXPERTS ADVISE YOU :

Soak the implant, the closing cap and the healing cap in an antibiotic (tobramycin or gentamicin type – 75 mg) diluted in 20 cl of physiological serum before placing it.

LIFE CYCLE :

The drills shall be replaced after 20 uses or as soon as their cutting capacity decreases. Used drills must be decontaminated or handled as waste of infectious risk care activities.

IDI Scientific Publications

Immediate Implant Placement Into Fresh Extraction Sites Using Single-Drilling Bur and Two Loading Procedures: Follow-Up Results

Raphaël Bettach, DDS, Silvio Taschieri, MD, DDS, Carmen Mortellaro, MD, DDS, and Massimo Del Fabbro, MSc, PhD
The Journal of Craniofacial Surgery- Volume 29, Number 8, November 2018

Osteotomy at Low-Speed Drilling without Irrigation Versus High-Speed Drilling with Irrigation: an Experimental Study

João GASPARGON, Gonçalo BORRECHO, Pedro OLIVEIRA, Francisco SALVADO, José MARTINS dos SANTOS
Acta Med Port 2013 May-Jun;26(3):231-236

Heat generation and drill wear during dental implant site preparation: systematic review

S.C. Möhlhenrich, A. Modabbera, T. Steiner, D.A. Mitchell, F. Hölzle
Br J Oral Maxillofac Surg (2015)

Evaluation of the insertion torque, implant stability quotient and drilled hole quality for different drill design: an in vitro Investigation

Sergio Alexandre Gehrke, Jose Luis Calvo Guirado, Raphaël Bettach, Massimo Del Fabbro, Carlos Perez-Albacete Martinez, Jamil Awad Shibli
Clin. Oral Impl. Res. 00, 2016, 1-7

Clinical evaluation of submerged and non-submerged implants for posterior single-tooth replacements: a randomized split-mouth clinical trial

S. K. Nemli, M. B. Güngör, C. Aydın, H. Yılmaz, I. Türkcan, H. Demirköprülü - Department of Prosthodontics, Faculty of Dentistry, Gazi University, Ankara, Turkey
Int. J. Oral Maxillofac. Surg. 2014; 43: 1484-1492

Clinical and radiographic evaluation of new dental implant system: Results of a 3 year prospective study

Seçil Karakoca Nemli, Merve Bangoglu Güngör, Cemal Aydın, Handan Yılmaz, Bilge Turhan Bal, Yeliz Kaşko Arıcı
Journal of dental Sciences (2015)

Réhabilitation implantaire des fentes labiopalatines : étude rétrospective sur dix ans

J. Lalo, A. Kayali, B. Toudjine, A. Majourau-Bouriez, H. Essad-dam, B. Pavy
2007 Elsevier Masson SAS. 10.1016/j.stomax.2007.01.005 Rev Stomatol Chir Maxillofac 2007;108:398-406

Les ostéotomies corticales d'augmentation alvéolaire en chirurgie implantaire

J. Lalo, A.-S. Véronis, J.-P. Lezy
(2012), Elsevier Masson SAS. Rev Stomatol Chir Maxillofac

L'expansion osseuse transversale pré-implantaire de la crête maxillaire par corticotomie alvéolaire

J. Lalo, V. Chassignolle, M. Beleh, M. Djemi
(2008), Elsevier Masson SAS. Rev Stomatol Chir Maxillofac

Implant Survival after Preparation of the Implant Site Using a Single Bur: A Case Series

Raphaël Bettach, DDS; Silvio Taschieri, MD, DDS; Gilles Boukhris, DDS; Massimo Del Fabbro, BSc, PhD
Clinical Implant Dentistry and Related Research, (2013)

Temperature Changes in Cortical Bone after Implant Site Preparation Using a Single Bur versus Multiple Drilling Steps: An In Vitro Investigation

Sergio Alexandre Gehrke, DDS; Raphaël Bettach, DDS; Silvio Taschieri, MD, DDS; Gilles Boukhris, DDS; Stefano Corbelli, DDS, PhD; Massimo Del Fabbro, BSc, PhD
Clinical Implant Dentistry and Related Research, (2013)

Clinical Performance of a Highly Porous Beta-TCP as the Grafting Material for Maxillary Sinus Augmentation

Raphael Bettach, DDS, Bernard Guillaume, MD, Silvio Taschieri, MD, DDS, and Massimo Del Fabbro, BSc, PhD
Implant Dentistry, (2014)

Find all the publications on :
www.idi-dental.com/documentation



Non contractual photos and illustrations.

Packaging for IDI implants

DOUBLE STERILE PACKAGING

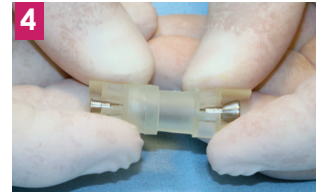
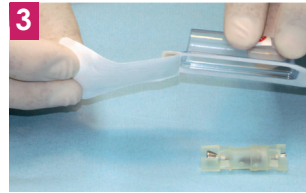
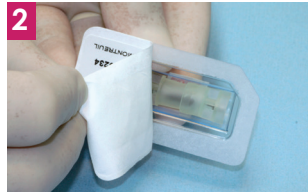

METHOD 1:

Pick up the implant with a contra-angle.



1
Press



2
Remove



METHOD 2:

Pick up the implant manually

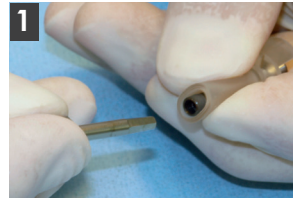

1
Press

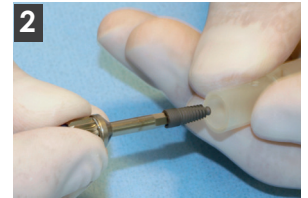

2
Remove



Pick up the closing cap from the packaging.

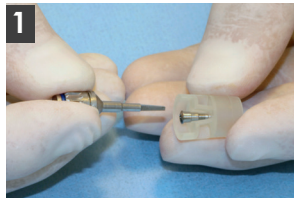

1
Take the packaging

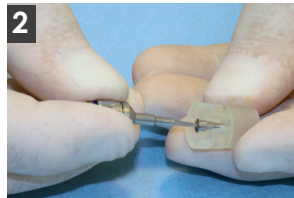

2
Pick

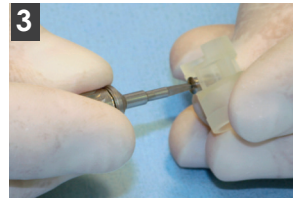

3
Rotate by 90°

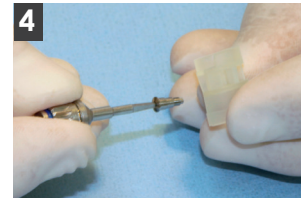

4
Remove



Pick up the healing cap from the lower part of the packaging.

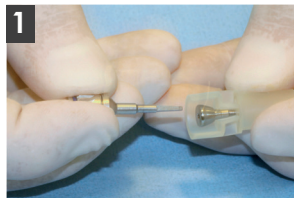

1
Take the packaging

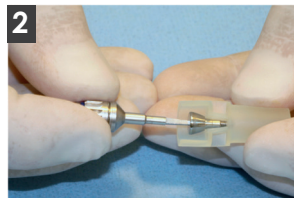

2
Pick

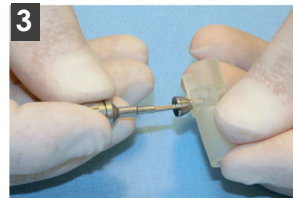

3
Rotate by 90°

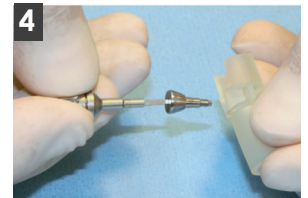

4
Remove

USEFUL TIPS

1. Clean the instruments in an ultrasonic bath during 15 minutes for decontamination.
2. Rinse abundantly.
3. Dry perfectly.
4. Sterilize (dry heat) at 150° C during 90 minutes or at the autoclave at 135° during 20 minutes.

IDI Warranty

1. SCOPE OF COVERAGE AND BENEFICIARIES

This warranty ("IDI Warranty" as defined below) of **IMPLANTS DIFFUSION INTERNATIONAL**, Montreuil, France ("IDI") applies to the products listed below; the attending physician/dentist (the "User") is the sole beneficiary. The IDI Warranty provides for the replacement of the products of the **IDI®** Dental Implant System (the "IDI Products"), listed in Section 2. It does not cover any of the associated costs.

2. IDI PRODUCTS COVERED BY THE IDI WARRANTY

The **IDI LIFETIME** warranty covers the replacement of implants and prosthetic abutments, if finalized, with equivalent products.

3. WARRANTY CONDITIONS

IDI guarantees the replacement of **IDI** products, following a defect in the strength or stability of the **IDI** product during the warranty period, by the same product or by an equivalent product in its function. The warranty period named above begins when the User processes with the **IDI** product. All the following warranty conditions must be met and documented:

- 3.1 Only **IDI** Products have been used and they have not been combined with products from other manufacturers.
- 3.2 **IDI** products were returned sterile and disinfected.
- 3.3 The Products have been used in accordance with **IDI**'s instructions as indicated in the instructions for use.
- 3.4 Good oral hygiene and biannual patient checks.
- 3.5 The warranty does not cover accidents, trauma caused by the patient.
- 3.6 The warranty form has been duly completed and signed within three months of the occurrence of the warranty case.

4. LIMITS AND LIMITATIONS

IDI HEREBY DISCLAIMS ALL OTHER WARRANTIES, EXPRESS OR IMPLIED, AND EXCLUDES ALL LIABILITY FOR LOST PROFITS, DIRECT OR INDIRECT DAMAGES OR COLLATERAL AND SPECIAL DAMAGES, DIRECTLY OR INDIRECTLY RELATED TO THE PRODUCTS, SERVICES OR INFORMATION PROVIDED.

5. AREA OF APPLICATION OF THE WARRANTY

This **IDI** Warranty applies worldwide to **IDI** products sold by an **IDI** affiliate or an official distributor of **IDI**.

6. MODIFICATION OR TERMINATION

IDI may at any time modify or terminate this **IDI** warranty, in whole or in part. Changes to the **IDI** Warranty, or termination, take effect after the date of such change or termination.

Photo : ©IDI - All the products in this catalogue are aiming to be used by health professionals. - Publications : February 2019.
Printed in France. All rights of reproduction prohibited for any country without written agreement. Non-contractual photos and illustrations.



IMPLANTS DIFFUSION INTERNATIONAL

23/25 rue Émile Zola - 93100 Montreuil - France
Phone. : +33 (0)1 48 70 70 48
Email : info@idi-dental.com

Find all the IDI product ranges on our website
www.idi-dental.com